

CONTINUOUS CHEVRON

Highly aggressive design for unmatched grip of belt to hay surface. 3 ply patented construction designed as **original equipment** for: **HESSTON:** 540, 545, 550, 555, 560, 565, 845, 855 and 856. **CASE IH:** 8430, 8435, 8450, 8455, 8460, 8465, RS451, RS551, RS561, RBX441, RBX451, RBX561.

NEW IDEA: 4644, 4664, 4665, 6344, 6345, 6364, 6365.

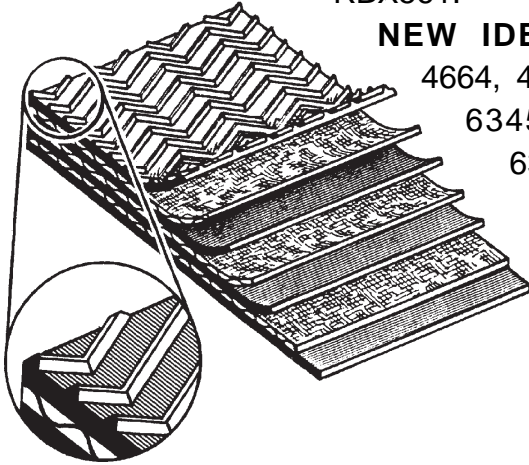

DIAMOND TOP

A proven performer for all John Deere Balers produced since 1981. 3 ply patented construction designed as **original equipment** and **replacement** for:

John Deere: 330, 335, 430, 435, 530, 535, 447, 456, 457, 466, 467, 556, 557.

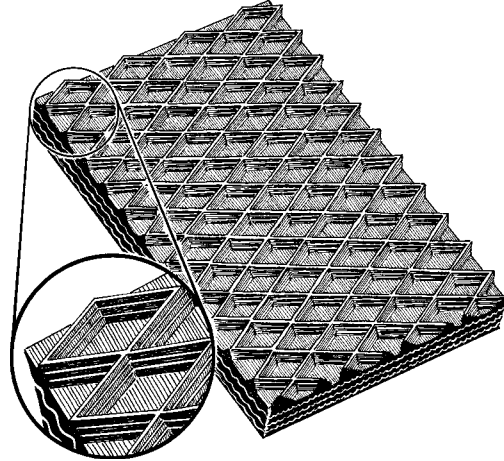

CHEVRON

Aggressive low profile design used by O.E.M.'s for over 20 years. 3 ply patented construction designed as **original equipment** for:

HESSTON: 5500, 5510. **GEHL:** 1470, 1475, 1870, 1875, 2580, 2680, 2880.

CASE-IH: 8440

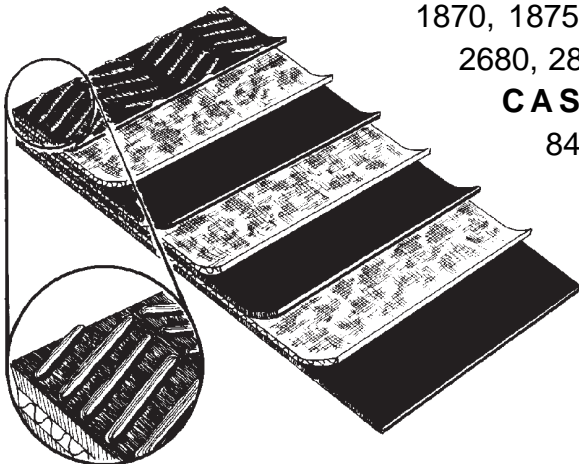

ROUGH TOP

Standard matrix rough top provides a positive gripping surface between belt and hay.

3 ply construction designed as **original equipment** for: **HESSTON:** 5540, 5580.

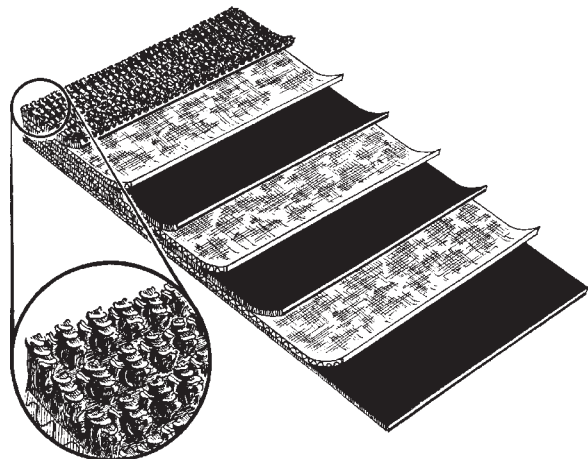

MINI ROUGH TOP (.30)

The heavy weight of MRT.
Low profile texture provides fast bale starts and gentle crop rotation. 3 ply patented construction designed as **original equipment** for: **NEW HOLLAND:** 650, 654, 658, 660, 664, 688.

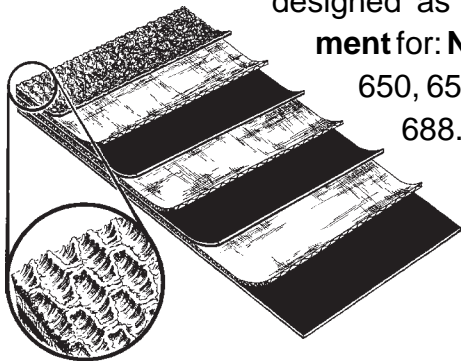

MINI ROUGH TOP (.26)

Our medium gauge MRT.
Same low profile texture provides fast bale starts and gentle crop rotation. 3 ply patented construction designed as **original equipment** for:

NEW HOLLAND: 630, 634, 640, 644, 648, 678.
HESSTON
(Late Models): 845, 846, 855, 856.
NEW IDEA
(Late Models): 6345, 6364, 6365

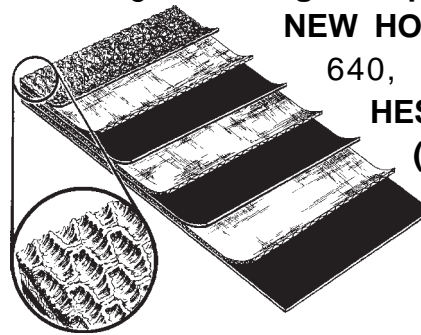

MINI ROUGH TOP (STANDARD)

Our standard gauge MRT.
Same low profile texture provides fast bale starts and gentle crop rotation. Patented 3 ply construction designed as **original equipment** for: **GEHL:** 1456, 1865, 2480, 2780.

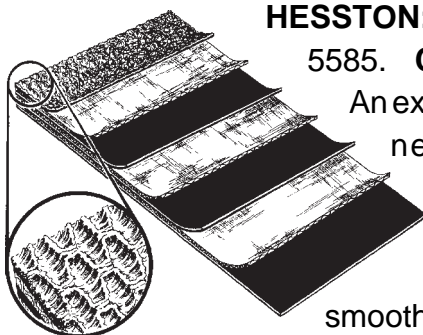

HESSTON: 530, 5545, 5565, 5585. **CASE-IH:** 8420.

An excellent choice when needing increased performance on older model balers which had smooth belts as original.

300 SERIES

3 ply patented construction designed for heavy weight baling operations and high density balers, using a smooth covered belt. Popular choice with **VERMEER:** 504, 505, 604, 605, F, G, H, I, J, K, L. **JOHN DEERE:** 410, 510.

MASSEY FERGUSON: 1400, 1455, 1500, 1560, 1565

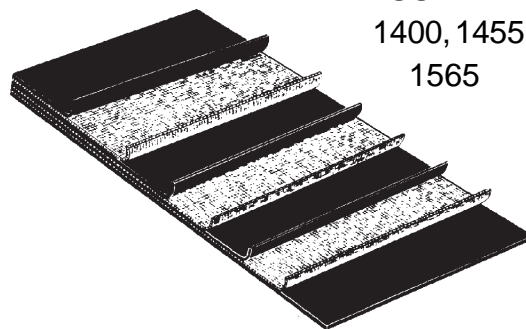

200 SERIES

2 ply construction with rubber cover on both sides. General purpose baler belt for use on older model lower density balers. **IHC:** 241, 2400. **VERMEER:** A, B, C, D, E. **GEHL:** 1450, 1460, 1850, 1860

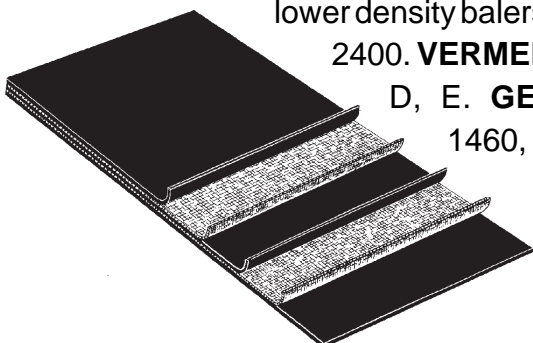

POPULAR BULK ROLLS STYLES & WIDTHS

4"	300 Series
6"	300 Series
6.5"	300 Series
9"	300 Series
10"	300 Series
4"	200 Series
10"	200 Series
7"	Continuous Chevron
7"	Diamond Top

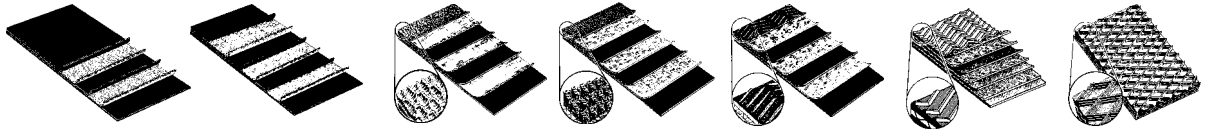

WIDTH	LENGTH	200S 2-PLY	300S 3-PLY	MINI Rough Top 3-PLY (Standard)	3RT 3-PLY	CHEVRON 3-PLY	CONT. Chevron 3-PLY	DIAMOND 3-PLY
4"	150 Ft.	70204000	70504000	71304000	N/A	71204000	N/A	N/A
	300 Ft.	70204000	70504000	71304000	N/A	71204000	N/A	N/A
	600 Ft.	70204000	70504000	71304000	N/A	71204000	N/A	N/A
4.75"	150 Ft.	70204750	70504750	71304750	N/A	N/A	N/A	N/A
	300 Ft.	70204750	70504750	71304750	N/A	N/A	N/A	N/A
	600 Ft.	70204750	70504750	71304750	N/A	N/A	N/A	N/A
5.3"	150 Ft.	N/A	N/A	71305300	734053	N/A	N/A	N/A
	300 Ft.	N/A	N/A	71305300	734053	N/A	N/A	N/A
	600 Ft.	N/A	N/A	71305300	734053	N/A	N/A	N/A
6"	150 Ft.	70206000	70506000	71306000	N/A	71206000	N/A	N/A
	300 Ft.	70206000	70506000	71306000	N/A	71206000	N/A	N/A
	600 Ft.	70206000	70506000	71306000	N/A	71206000	N/A	N/A
6.5"	150 Ft.	70206500	70506500	N/A	N/A	71206503	N/A	N/A
	300 Ft.	70206500	70506500	N/A	N/A	71206503	N/A	N/A
	600 Ft.	70206500	70506500	N/A	N/A	71206503	N/A	N/A
7"	150 Ft.	New Holland	650 - 654 - 658	71307004	John Deere	330 - 335 - 375 - 430 - 435		71207009
	300 Ft.		660 - 664 - 688	71307004		466 - 467 - 457 - 466 - 467		71207009
	450 Ft.		3 MRT (.30)	71307004		530 - 535 - 556 - 557 - 567		71207009
7"	150 Ft.	CASE-IH (Late Models) HESSTON (Late Models)	New Holland	71307026	N/A	N/A	N/A	N/A
	300 Ft.		630/640 Series	71307026	N/A	N/A	N/A	N/A
	600 Ft.		3 MRT (.26)	71307026	N/A	N/A	N/A	N/A
7"	150 Ft.	70207000	70507000	71307000	N/A	N/A	71207000	N/A
	300 Ft.	70207000	70507000	71307000	N/A	N/A	71207000	N/A
	600 Ft.	70207000	70507000	71307000	N/A	N/A	71207000 ⁽⁴⁵⁰⁾	N/A
9"	150 Ft.	70209000	70509000	71309000	N/A	N/A	N/A	N/A
	300 Ft.	70209000	70509000	71309000	N/A	N/A	N/A	N/A
	600 Ft.	70209000	70509000	71309000	N/A	N/A	N/A	N/A
10"	150 Ft.	70210000	70510000	71310000	N/A	N/A	N/A	N/A
	300 Ft.	70210000	70510000	71310000	N/A	N/A	N/A	N/A
	600 Ft.	70210000	70510000	71310000	N/A	N/A	N/A	N/A
11"	150 Ft.	70211000	70511000	71311000	N/A	N/A	N/A	N/A
	300 Ft.	70211000	70511000	71311000	N/A	N/A	N/A	N/A
	600 Ft.	70211000	70511000	71311000	N/A	N/A	N/A	N/A
12"	150 Ft.	70212000	70512000	71312000	N/A	N/A	N/A	N/A
	300 Ft.	70212000	70512000	71312000	N/A	N/A	N/A	N/A
	600 Ft.	70212000	70512000	71312000	N/A	N/A	N/A	N/A
14"	150 Ft.	N/A	70514000	N/A	N/A	N/A	N/A	N/A
	300 Ft.	N/A	70514000	N/A	N/A	N/A	N/A	N/A
	600 Ft.	N/A	70514000	N/A	N/A	N/A	N/A	N/A

Roll lengths may vary + - 5%. Invoice will reflect actual footage. Roll belting is priced and sold per foot. When ordering, order the number of feet as listed in length column.

"DUTCHMAN" PIECES FOR REPAIRING BELTING (SOLD WITHOUT LACING)



WIDTH	LENGTH	200S 2-PLY	300S 3-PLY	MINI ROUGH 3-PLY	3RT 3-PLY	CHEVRON 3-PLY	CONT. CHEV. 3-PLY	DIAMOND TOP 3-PLY
4"	6 Ft.	70204001	70504001	71304009	N/A	71204001	71204005	N/A
4.8"	6 Ft.	N/A	N/A	71304803	N/A	N/A	N/A	N/A
5.3"	6 Ft.	N/A	N/A	71305301	73405	N/A	71205301	N/A
6"	6 Ft.	70206001	70506001	71306001	N/A	71206001	N/A	N/A
6.5"	6 Ft.	70206501	70506501	N/A	N/A	712065031	71206501	N/A
7"	6 Ft.	Thicker 3MRT (.30)		71307006	N/A	N/A	N/A	N/A
7"	6 Ft.	Thicker 3MRT (.26)		713070261	N/A	N/A	N/A	N/A
7"	6 Ft.	N/A	N/A	71307001	N/A	N/A	71207003	71207004
9"	6 Ft.	70209001	70509002	71309001	N/A	N/A	N/A	N/A
10"	6 Ft.	70210001	70510001	71310001	N/A	N/A	N/A	N/A
12"	6 Ft.	70212001	70512001	71312001	N/A	N/A	N/A	N/A
14"	6 Ft.	N/A	70514001	N/A	N/A	N/A	N/A	N/A

READY MADE ASSEMBLIES WITH CLIPPER LACE ATTACHED





MAKE & MODEL #	# BELTS PER BALER	BELT DIMENSIONS	200S 2-PLY	300S 3-PLY	MINI ROUGH TOP 3-PLY	ROUGH TOP CHEVRON CONT. CHEVRON 3-PLY
ALLIS CHALMERS - Roto Baler			ALLIS CHALMERS - Roto Baler			
(70509672) Top	6	5.5" x 72"	702055072	N/A	N/A	N/A
(70509673) Bottom	6	5.5" x 102"	702055102	N/A	N/A	N/A
CASE IH			CASE IH			
241-2400			CASE IH			
(205810092)	9	4" x 430"	70204430	70504430	71304430	N/A
		10" x 430"	70210430	70510430	71310430	N/A
Popular Belt Modification: (5) 4" x 430" Inside and (2) 10" x 430" Outside						
2400 Dual Springs			CASE IH			
	9	4" x 424"	70204424	70504424	71304424	N/A
		10" x 424"	70210430	70510430	71310430	N/A
3440			(See technical notes)			
(ZA104107) Top	12	11" x 73.25"	7021107325	7051107325	71311073	N/A
(ZA104712) Bottom	4	11" x 103.5"	70211103	70511103	71311103	N/A
3450 Early Model			(See technical notes)			
(ZA104107) Top	30	4.75" x 73.25"	702047573	705047573	71304757	N/A
(ZA104712) Bottom	5	11" x 103.5"	70211103	70511103	71311103	N/A
3450 Newer Models			(See technical notes)			
(ZA105003) Top	15	11" x 73.25"	7021107325	7051107325	71311073	N/A
(ZA104712) Bottom	5	11" x 103.5"	70211103	70511103	71311103	N/A
3640			(See technical notes)			
(ZA104107) Top	20	11" x 73.25"	7021107325	7051107325	71311073	N/A
(ZA104108) Bottom	4	11" x 121"	70211121	70511121	71311121	N/A

TECHNICAL NOTES: For faster bale starts of fixed chamber (soft core) balers, install 3MRT series belts, especially on the bottom and lower tailgate areas. The **textured bottom assists** in pulling hay into the bale chamber while the **lower** tailgate belts turn the hay in starting the core.













READY MADE ASSEMBLIES WITH CLIPPER LACE ATTACHED. (See Optional Titan or Flexco Rivet)

MAKE & MODEL #	# BELTS PER BALER	BELT DIMENSIONS	200S 2-PLY	300S 3-PLY	MINI ROUGH TOP 3-PLY	ROUGH TOP CHEVRON CONT. CHEVRON 3-PLY
CASE IH		CASE IH			CASE IH	
3650 Early Models		(See TECHNICAL NOTES on previous page)				
(ZA104107) Top	55	4.75" x 73.25"	702047573	705047573	71304757	N/A
(ZA104108) Bottom	5	11" x 121"	70211121	70511121	71311121	N/A
8480-3650 Newer Models		(See TECHNICAL NOTES on previous page)				
(ZA105003) Top	25	11" x 73.25"	7021107325	7051107325	71311073	N/A
(ZA104108) Bottom	5	11" x 121"	70211121	70511121	71311121	N/A
8420						
(700700802)	5	4.8" x 364"	N/A	N/A	7130483641	N/A
8430						
(700709185)	6	7" x 366"	3 PLY CONTI. CHEVRON/CLIPPER LACE		71207366	
OR						
(700713890)		7" x 366"	3 PLY CONTI. CHEVRON/TITAN LACE		712073661	
OR						
		7" x 366"	3 PLY CONTI. CHEVRON/FLEXCO RIVET		712073662	
8435						
	6	7" x 471.5"	3 PLY CONTI. CHEVRON/TITAN LACE		71207471	
8440						
(700702917)	9	4" x 452"	3 PLY CHEVRON/CLIPPER LACE		71204452	
OR						
Optional Newer Style		4" x 452"	3 PLY CONTI. CHEVRON/CLIPPER LACE		712044521	
TECHNICAL NOTES: DO NOT MIX regular chevron belts with the more aggressive continuous chevron belts. Continuous chevron belts should be installed as a set.						
8450						
(700707162)	4	7" x 570"	3 PLY CONTI. CHEVRON/CLIPPER LACE		71207570	
(700708740)	2	6.5" x 572.5"	3 PLY CONTI. CHEVRON/CLIPPER LACE		71206572	
OR						
8450						
(700713630)	4	7" x 570"	3 PLY CONTI. CHEVRON/TITAN LACE		712075701	
	2	6.5" x 572.5"	3 PLY CONTI. CHEVRON/TITAN LACE		712065721	
8455						
(700709999)	6	7" x 562.5"	3 PLY CONTI. CHEVRON/CLIPPER LACE		71207562	
OR						
(700713617)		7" x 562.5"	3 PLY CONTI. CHEVRON/TITAN LACE		712075621	
OR						
		7" x 562.5"	3 PLY CONTI. CHEVRON/FLEXCO RIVET		712075622	







READY MADE ASSEMBLIES WITH CLIPPER LACE ATTACHED (See Optional Titan or Flexco Rivet)

MAKE & MODEL #	# BELTS PER BALER	BELT DIMENSIONS	200S 2-PLY	300S 3-PLY	MINI ROUGH TOP 3-PLY	ROUGH TOP CHEVRON CONT. CHEVRON 3-PLY
TECHNICAL NOTES: Refer to the last 4 digits of the baler serial number to determine proper belt length for the 8460 model balers.						
8460 Earlier with Serial numbers up to CFH0057417						
(700707162)	6	7" x 570"	3 PLY CONTI. CHEVRON/CLIPPER LACE		71207570	
(700708740)	2	6.5" x 572.5"	3 PLY CONTI. CHEVRON/CLIPPER LACE		71206572	
OR						
8460 Earlier with Serial numbers CFH0057418 and up						
(700713630)	6	7" x 570"	3 PLY CONTI. CHEVRON/TITAN LACE		712075701	
	2	6.5" x 572.5"	3 PLY CONTI. CHEVRON/TITAN LACE		712065721	
8460 Newer with Serial numbers CFH0057418 and up						
(700709999)	8	7" x 562.5"	3 PLY CONTI. CHEVRON/CLIPPER LACE		71207562	
OR						
8460 Newer (700713617)		7" x 562.5"	3 PLY CONTI. CHEVRON/TITAN LACE		712075621	
OR						
		7" x 562.5"	3 PLY CONT. CHEVRON/FLEXCO RIVET		712075622	
8465						
(700709999)	8	7" x 562.5"	3 PLY CONTI. CHEVRON/CLIPPER LACE		71207562	
OR						
(700713617)		7" x 562.5"	3 PLY CONTI. CHEVRON/TITAN LACE		712075621	
OR						
		7" x 562.5"	3 PLY CONT. CHEVRON/FLEXCO RIVET		712075622	
CASE IH STARTER FLAPS						
8450-8455 ALL MODELS						
(700711998)	4	3.5" x 46.22"	N/A	N/A	71303546	N/A
8460-8465 ALL MODELS						
(700711997)	4	3.5" x 61.18"	N/A	N/A	71303562	N/A
TECHNICAL NOTES: For optimal baler performance, starter flaps should be replaced every 2,500 bales.						
CASE IH RS451						
(700716049)		6	7" x 475"	3 PLY CONTI. CHEVRON/TITAN LACE		712074753
OR						
		7" x 475"	3 PLY CONTI. CHEVRON/FLEXCO RIVET		712074752	
OR						
		7" x 475"	3 PLY MRT (.26) / TITAN LACE (Late Model) TECHNICAL NOTES: You may notice .26 or .30 thick MRT belts for late model Case-IH, Hesston & New Idea balers. Both are O.E.M. specified.		713074751	
RS451 STARTER FLAPS						
(700716010)		3.5" x 43.31"	N/A	N/A	71303543	N/A



READY MADE ASSEMBLIES WITH CLIPPER LACE ATTACHED (See Optional Titan or Flexco Rivet)

MAKE & MODEL #	# BELTS PER BALER	BELT DIMENSIONS	200S 2-PLY	300S 3-PLY	MINI ROUGH TOP 3-PLY	ROUGH TOP CHEVRON CONT. CHEVRON 3-PLY
RS551						
(700716049) 	8	7" x 475"	3 PLY CONTI. CHEVRON/TITAN LACE			712074753
OR						
		7" x 475"	3 PLY CONTI. CHEVRON/FLEXCO RIVET			712074752
OR						
		7" x 475"	3 PLY MRT (.26) / TITAN LACE (Late Model)			713074751
RS551/561 STARTER FLAPS						
(788717714)		3.5" x 58.5"	N/A	N/A	71303558	N/A
RS561						
(700717717) 	8	7" x 547"	3 PLY CONTI. CHEVRON/TITAN LACE			712075471
OR						
		7" x 547"	3 PLY CONTI. CHEVRON/FLEXCO RIVET			712075472
OR						
(700728088) 		7" x 547"	3 PLY MRT (.26) / TITAN LACE (Late Model)			713075471
TECHNICAL NOTES: You may choose to replace late production MRT series belts with the popular Continuous Chevron Belts (when installed as a complete set). Do not mix MRT style belts with or next to Continuous Chevron belts.						
CNH - CASE IH TECHNICAL NOTES: As of catalog printing, heavy duty plate fasteners are not recommended for the RBX series baler.						
RBX441						
(86616064) 	6	7" x 272.5"	3 PLY CONTI. CHEVRON/CLIPPER LACE			71207272
RBX451						
(86616065) 	6	7" x 343"	3 PLY CONTI. CHEVRON/CLIPPER LACE			71207343
OR						
(86616068) 		7" x 343"	3 PLY CONT. CHEVRON/ENDLESS			712073434
RBX461						
(86616066) 	6	7" x 420.5"	3 PLY CONTI. CHEVRON/CLIPPER LACE			71207420
RBX561						
(86616066) 	8	7" x 420.5"	3 PLY CONTI. CHEVRON/CLIPPER LACE			71207420
OR						
(86616069) 		7" x 420.5"	3 PLY CONTI. CHEVRON/ENDLESS			712074204
CNH - CASE IH - SLEDGE ROLL BELT CLEANER STRIP						
RBX451-RBX461-RBX561		7" x 45"	N/A	N/A	71307045	
(86548820)		7" x 59.8"	N/A	N/A	71307059	N/A
CNH - CASE IH - BELT SCRAPER AND CLEANING STRIP						
RBX451-RBX461						
(9848760) 		5" x 45"	N/A	N/A	71305045	N/A
RBX561						
(9848759)		5" x 59.5"	N/A	N/A	71305059	N/A





READY MADE ASSEMBLIES WITH CLIPPER LACE ATTACHED (See Optional Flexco Lace)

MAKE & MODEL #	# BELTS PER BALER	BELT DIMENSIONS	200S 2-PLY	300S 3-PLY	MINI ROUGHTOP 3-PLY	ROUGHTOP CHEVRON CONT. CHEVRON 3-PLY
GEHL						
GEHL						
GEHL						
(TECHNICAL NOTES: It is recommended for the model 1400 Gehl balers with 5" inside belts be converted to 6" wide belts)						
1400 (120810)	5	6" x 450"	70206450	70506450	71306450	N/A
(TECHNICAL NOTES: 2 Ply Belt is Required for the 1450 Model)						
1450-1460 (120811)	5	6" x 462.5"	70206462	70506462	N/A	N/A
1465-1470 Early Models						
(084681)	6	6" x 462.5"	N/A	N/A	71306462	N/A
1470 (Newer)						
(125951)	6	6" x 463"	3 PLY REGULAR CHEVRON/ CLIPPER LACE			71206463
1475						
(119476)	6	6" x 469"	3 PLY REGULAR CHEVRON/ CLIPPER LACE			71206469
1500						
(056479)	9	4" x 466"	70204466	70504466	71304466	N/A
		10" x 466"	70210466	70510466	71310466	N/A
1500A-1600						
(120812)	6	6" x 466"	70206466	70506466	71306466	N/A
(TECHNICAL NOTES: 2 Ply Belt is Required for the 1850 Model)						
1850-1860 (120813)	7	6" x 545.25"	70206545	70506545	N/A	N/A
1865-1870 Early Models						
(084722)	8	6" x 545.25"	N/A	N/A	71306545	N/A
1870 (Newer)						
(125952)	8	6" x 545.25"	3 PLY REGULAR CHEVRON/ CLIPPER LACE			71206545
1875						
(119477)	8	6" x 552"	3 PLY REGULAR CHEVRON/ CLIPPER LACE			71206552
2480						
(156649) 	6	6" x 468.5"	N/A	N/A	713064681	N/A
2580						
(155501)  (155500)	2	6.5" x 502.5"	3 PLY REGULAR CHEVRON/ FLEXCO RIVET			712065022
	4	6.5" x 474.5"	3 PLY REGULAR CHEVRON/ FLEXCO RIVET			712064742
2680						
(155503)  (155505)	2	6.5" X 556.5"	3 PLY REGULAR CHEVRON/ FLEXCO RIVET			712065562
	4	6.5" x 577.5"	3 PLY REGULAR CHEVRON/ FLEXCO RIVET			712065772
2780						
(156649) 	8	6" x 468.5"	N/A	N/A	713064681	N/A
2880						
(155503)  (155505)	4	6.5" x 556.5"	3 PLY REGULAR CHEVRON/ FLEXCO RIVET			712065562
	4	6.5" x 577.5"	3 PLY REGULAR CHEVRON/ FLEXCO RIVET			712065772
NET WRAP FEEDING BELTS						
1470-1475						
(118659) 		6" x 52.25"	REGULAR CHEVRON		N/A	71206052
1870-1875						
(118660) 		6" x 64.75"	REGULAR CHEVRON		N/A	71206064

READY MADE ASSEMBLIES WITH CLIPPER LACE ATTACHED (See Optional Titan or Flexco Rivet)

MAKE & MODEL #	# BELTS PER BALER	BELT DIMENSIONS	200S 2-PLY	300S 3-PLY	MINI ROUGHTOP 3-PLY	ROUGHTOP CHEVRON CONT. CHEVRON 3-PLY
HESSTON/AGCO			HESSTON/AGCO			HESSTON/AGCO
514 / 814						
	25	11" x 73.25"	7021107325	7051107325	71311073	N/A
	5	11" x 121"	70211121	70511121	71311121	N/A
TECHNICAL NOTES: For faster bale starts of fixed chamber (soft core) balers, install 3MRT series belts, especially on the bottom and lower tailgate areas. The textured bottom assists in pulling hay into the bale chamber while the lower tailgate belts turn the hay in starting the core.						
530 - 5530 - 830						
(700700802)	5	4.8" x 364"	N/A	N/A	7130483641	N/A
540 - 740 - 840						
Your Choice of Clipper, Titan OR Rivet Laced Belts						
(700709185)	6	7" x 366"	3 PLY CONTI. CHEVRON/ CLIPPER LACE			71207366
OR						
(700713890)		7" x 366"	3 PLY CONTI. CHEVRON/ TITAN LACE			712073661
OR						
		7" x 366"	3 PLY CONTI. CHEVRON/ FLEXCO RIVET			712073662
OR						
(700725099)		7" x 366"	3 PLY MRT (.26) / TITAN LACE (Late Model)			713073661
550						
(700707162)	4	7" x 570"	3 PLY CONTI. CHEVRON/ CLIPPER LACE			71207570
(700708740)	2	6.5" x 572.5"	3 PLY CONTI. CHEVRON/ CLIPPER LACE			71206572
OR						
(700713630)	4	7" x 570"	3 PLY CONTI. CHEVRON/ TITAN LACE			712075701
	2	6.5" x 572.5"	3 PLY CONTI. CHEVRON/ TITAN LACE			712065721
545						
	6	7" x 471.5"	3 PLY CONTI. CHEVRON/ TITAN LACE			71207471
555						
(700709999)	6	7" x 562.5"	3 PLY CONTI. CHEVRON/ CLIPPER LACE			71207562
OR						
(700713617)		7" x 562.5"	3 PLY CONTI. CHEVRON/ TITAN LACE			712075621
OR						
		7" x 562.5"	3 PLY CONTI. CHEVRON/ FLEXCO RIVET			712075622
HESSTON STARTER FLAPS						
550-555						
(700711998)	4	3.5" x 46.22"	N/A	N/A	71303546	N/A

READY MADE ASSEMBLIES WITH CLIPPER LACE ATTACHED (See Optional Titan or Flexco Rivet)

MAKE & MODEL #	# BELTS PER BALER	BELT DIMENSIONS	200S 2-PLY	300S 3-PLY	MINI ROUGHTOP 3-PLY	ROUGHTOP CHEVRON CONT. CHEVRON 3-PLY
HESSTON/AGCO			HESSTON/AGCO			HESSTON/AGCO
560 Older Models with Serial numbers from 0220 to 1964						
(700707162)	6	7" x 570"	3 PLY CONTI. CHEVRON/CLIPPER LACE		71207570	
(700708740)	2	6.5" x 572.5"	3 PLY CONTI. CHEVRON/CLIPPER LACE		71206572	
OR						
(700713617)	6	7" x 570"	3 PLY CONTI. CHEVRON/TITAN LACE		712075701	
	2	6.5" x 572.5"	3 PLY CONTI. CHEVRON/TITAN LACE		712065721	
560 Newer Models with Serial numbers 1965 and up						
(700709999)	8	7" x 562.5"	3 PLY CONTI. CHEVRON/CLIPPER LACE		71207562	
OR						
(700713617)		7" x 562.5"	3 PLY CONTI. CHEVRON/TITAN LACE		712075621	
565 Your choice of Clipper, Titan OR Rivet Laced Belts						
(700709999)	8	7" x 562.5"	3 PLY CONTI. CHEVRON/CLIPPER LACE		71207562	
OR						
(700713617)		7" x 562.5"	3 PLY CONTI. CHEVRON/TITAN LACE		712075621	
OR						
		7" x 562.5"	3 PLY CONTI. CHEVRON/FLEXCO RIVET		712075622	
OR						
		7" x 562.5"	3 PLY MRT (.26) / TITAN LACE (Late Model)		713075621	
HESSTON STARTER FLAPS						
560-565						
(700711997)	4	3.5" x 61.18"	N/A	N/A	71303562	N/A
845						
(700716049)	6	7" x 475"	3 PLY CONTI. CHEVRON/TITAN LACE		712074753	
OR						
		7" x 475"	3 PLY CONTI. CHEVRON/FLEXCO RIVET		712074752	
OR						
		7" x 475"	3 PLY MRT (.26) / TITAN LACE (Late Model)		713074751	
845 STARTER FLAPS						
(700716010)		3.5" x 43.31"	N/A	N/A	71303543	N/A
855						
(700716049)	8	7" x 475"	3 PLY CONTI. CHEVRON/TITAN LACE		712074753	
OR						
		7" x 475"	3 PLY CONTI. CHEVRON/FLEXCO RIVET		712074752	
OR						
		7" x 475"	3 PLY MRT (.26) / TITAN LACE (Late Model)		713074751	
	TECHNICAL NOTES: You may notice .26 or .30 thick MRT belts for late model Case-IH, Hesston and New Idea balers. Both are O.E.M. specified.		TECHNICAL NOTES: You may choose to replace late production MRT series belts with the popular Continuous Chevron belts (when installed as a complete set). Do not mix MRT style belts with or next to Continuous Chevron belts.			
855 STARTER FLAPS						
(7007177111)		3.5" x 58.50"	N/A	N/A	71303558	N/A

READY MADE ASSEMBLIES WITH CLIPPER LACE ATTACHED (See Optional Titan or Flexco Rivet)

MAKE & MODEL #	# BELTS PER BALER	BELT DIMENSIONS	200S 2-PLY	300S 3-PLY	MINI ROUGH TOP 3-PLY	ROUGHTOP CHEVRON CONT. CHEVRON 3-PLY
HESSTON/AGCO						
846/A (700717717)	HESSTON/AGCO					
	6	7" x 547"	3 PLY CONTI. CHEVRON/TITAN LACE		712075471	
	OR					
		7" x 547"	3 PLY CONTI. CHEVRON/FLEXCO RIVET		712075472	
	OR					
		7" x 547"	3 PLY MRT (.26) / TITAN LACE (Late Model)		713075471	
846 STARTER FLAPS						
(700716010)		3.5" x 43.31"	N/A	N/A	71303543	N/A
856/A						
(700717717)	8	7" x 547"	3 PLY CONTI. CHEVRON/TITAN LACE		712075471	
	OR					
		7" x 547"	3 PLY CONTI. CHEVRON/FLEXCO RIVET		712075472	
	OR					
		7" x 547"	3 PLY MRT (.26) / TITAN LACE (Late Model)		713075471	
856 STARTER FLAPS						
(700717714)		3.5" x 58.50"	N/A	N/A	71303558	N/A
5400 With Holes						
(728733)	9	4" x 127"	70204127	70504127	71304127	N/A
5500-5510 (TECHNICAL NOTES: Do not mix regular chevron with the more aggressive continuous chevron belts)						
(700702917)	9	4" x 452"	3 PLY CHEVRON		71204452	
Optional Newer Style	9	4" x 452"	3 PLY CONTINUOUS CHEVRON		712044521	
5540						
(828335)	6	5.3" x 470"	3 PLY ROUGH TOP		73405470	
Optional Newer Style		5.3" x 470"	3 PLY CONTINUOUS CHEVRON		71205470	
5545 (TECHNICAL NOTES: Do not mix rough top or MRT with the more aggressive continuous chevron belts)						
(700703532)	6	5.3" x 465"	3 PLY MINI ROUGH TOP		71305465	N/A
Optional Newer Style		5.3" x 465"	3 PLY CONTINUOUS CHEVRON		71205465	
5580						
(828335)	8	5.3" x 470"	3 PLY ROUGH TOP		73405470	
Optional Newer Style		5.3" x 470"	3 PLY CONTINUOUS CHEVRON		71205470	
5585 (TECHNICAL NOTES: Do not mix rough top or MRT with the more aggressive continuous chevron belts)						
(700703532)	8	5.3" x 465"	3 PLY MINI ROUGH TOP		71305465	N/A
Optional Newer Style		5.3" x 465"	3 PLY CONTINUOUS CHEVRON		71205465	
5600						
(728758)	9	4" x 400"	70204400	70504400	71304400	N/A
		10" x 400"	70210400	70510400	71310400	N/A
5800						
(7827991)	9	4" x 480"	N/A	70504480	71304480	N/A
(Requires Kit)		10" x 480"	N/A	70510480	71310480	N/A



MAKE & MODEL #	# BELTS PER BALER	BELT DIMENSIONS	200S 2-PLY	300S 3-PLY	MINI ROUGH TOP 3-PLY	DIAMOND TOP CONT. CHEVRON 3-PLY
JOHN DEERE			JOHN DEERE		JOHN DEERE	
410						
(AE35930)	6	4" x 415"	70204415	70504415	71304415	N/A
		10" x 415"	70210415	70510415	71310415	N/A
(AE41723) Kit Required		12" x 417.5"	70212417	70512417	71312417	N/A
Popular Belt Modification: (2) 4" x 415" Inside and (2) 10" x 415" Outside						
500						
(AE33990)	9	4" x 422"	70204422	70504422	71304422	N/A
		10" x 422"	70210422	70510422	71310422	N/A
Popular Belt Modification: (5) 4" x 422" Inside and (2) 10" x 422" Outside						
510						
(AE35484)	9	4" x 484"	70204484	70504484	71304484	N/A
		10" x 484"	70210484	70510484	71310484	N/A
(AE37525) Requires JD Kit		12" x 486.5"	702124865	70512486	71312486	N/A
Popular Belt Modification: (5) 4" x 484" Inside and (2) 10" x 484" Outside						
330, 335, 446, 447						
4	2	7" x 402.75"	3 PLY DIAMOND TOP/FLEXCO RIVET			712074022
	7"	7" x 410.25"	3 PLY DIAMOND TOP/FLEXCO RIVET			712074102
OR						
AE53286	2	7" x 402.75"	3 PLY CONTI. CHEVRON/CLIPPER LACE			71207402
AE53287	4	7" x 410.25"	3 PLY CONTI. CHEVRON/CLIPPER LACE			71207410
375, 546, 547						
	4	7" x 402.75"	3 PLY DIAMOND TOP/FLEXCO RIVET			712074022
	4	7" x 410.25"	3 PLY DIAMOND TOP/FLEXCO RIVET			712074102
OR						
AE53286	4	7" x 402.75"	3 PLY CONTI. CHEVRON/CLIPPER LACE			71207402
AE53287	4	7" x 410.25"	3 PLY CONTI. CHEVRON/CLIPPER LACE			71207410
385, 456, 457						
456 Silage						
	2	7" x 461"	3 PLY DIAMOND TOP/FLEXCO RIVET			712074612
	4	7" x 466.5"	3 PLY DIAMOND TOP/FLEXCO RIVET			712074662
OR						
AE53288	2	7" x 461"	3 PLY CONTI. CHEVRON/CLIPPER LACE			71207461
AE53289	4	7" x 466.5"	3 PLY CONTI. CHEVRON/CLIPPER LACE			71207466
556, 557						
	4	7" x 461"	3 PLY DIAMOND TOP/FLEXCO RIVET			712074612
	4	7" x 466.5"	3 PLY DIAMOND TOP/FLEXCO RIVET			712074662
OR						
AE53288	4	7" x 461"	3 PLY CONTI. CHEVRON/CLIPPER LACE			71207461
AE53289	4	7" x 466.5"	3 PLY CONTI. CHEVRON/CLIPPER LACE			71207466
430, 435, 466, 467						
AE52287	2	7" x 525"	3 PLY DIAMOND TOP/FLEXCO RIVET			712075252
AE52288	4	7" x 531"	3 PLY DIAMOND TOP/FLEXCO RIVET			712075312
OR						
AE53295	2	7" x 525"	3 PLY CONTI. CHEVRON/CLIPPER LACE			71207525
AE53296	4	7" x 531"	3 PLY CONTI. CHEVRON/CLIPPER LACE			71207531

REPAIR TIPS: When resizing Deere belts back to original length, consider this. Instead of adding repair pieces to lengthen all belts, take the original long belts and cut them back to the original short belt length (no repair piece needed). Take the original short belts and add a repair piece and lengthen them to the original long belts. RESULTS: Fewer double belt splices.

TECHNICAL NOTE: It is critical to have a 6" length difference between the long and short belts.



MAKE & MODEL #	# BELTS PER BALER	BELT DIMENSIONS	200S 2-PLY	300S 3-PLY	MINI ROUGH TOP 3-PLY	DIAMOND TOP CONT. CHEVRON 3-PLY	
JOHN DEERE		JOHN DEERE			JOHN DEERE		
530, 535, 566, 567							
AE52287	4	7" x 525"	3 PLY DIAMOND TOP/FLEXCO RIVET		712075252		
AE52288	4	7" x 531"	3 PLY DIAMOND TOP/FLEXCO RIVET		712075312		
OR							
AE53295	4	7" x 525"	3 PLY CONTI. CHEVRON/CLIPPER LACE		71207525		
AE53296	4	7" x 531"	3 PLY CONTI. CHEVRON/CLIPPER LACE		71207531		
MASSEY FERGUSON		GREENLAND (RV)		RIVERRE CASSALIS (RC)		DEUTZ-FAHR	
450							
(1047868M93)	8	4" x 388"	70204388	70504388	71304388	N/A	
		9" x 388"	70209388	70509388	71309388	N/A	
1440 - 1450							
(1059229M91)	8	4" x 436"	70204436	70504436	71304436	N/A	
(1059230M91)		10" x 436"	70210436	70510436	71310436	N/A	
Popular Belt Modification: (4) 4" x 436" Inside and (2) 10" x 436" Outside							
1455							
(1059229M91)	8	4" x 436"	N/A	70504436	71304436	N/A	
		9" x 436"	N/A	70509436	71309436	N/A	
Popular Belt Modification: (4) 4" x 436" Inside and (2) 9" x 436" Outside							
560							
(1045352M93)	9	4" x 440"	70204440	70504440	71304440	N/A	
(1096895M91)		10" x 440"	70210440	70510440	71310440	N/A	
Popular Belt Modification: (5) 4" x 440" Inside and (2) 10" x 440" Outside or (4) 10" x 440" Outside and (1) 4" x 440" in the Middle							
1500 - 1560							
Inside Conversion	6	4" x 512"	70204512	70504512	71304512	N/A	
	2	10" x 512"	70210512	70510512	71310512	N/A	
	(3)	9" x 512"	70209512	70509512	71309512	N/A	
Popular Belt Modification: (3) 9" x 512" Inside and (2) 10" x 512" Outside							
1565							
	6	4" x 512"	N/A	70504512	71304512	N/A	
	2	9" x 512"	N/A	70509512	71309512	N/A	
Popular Belt Modification: (5) 9" x 512" Belts (Inside and Outside)							
645							
	6	6.5" x 528"	N/A	705065528	N/A	N/A	
656							
	8	6.5" x 528"	N/A	705065528	N/A	N/A	
822 (MF 130 EURO) RV 116 / RC 125							
Front	6	6" x 186"	3MRT / TITAN LACE		713061861	N/A	
Rear	6	6" x 225"	3MRT / TITAN LACE		713062251	N/A	
828 (MF 180 EURO) RV126 - RV186 / DF RB3.80 / Claas Variant 180							
Front	6	6" x 210"	3MRT / TITAN LACE		713062101	N/A	
Rear	6	6" x 305"	3MRT / TITAN LACE		713063051	N/A	

READY MADE ASSEMBLIES WITH CLIPPER LACE ATTACHED (See optional Titan Lace)





MAKE & MODEL #	# BELTS PER BALER	BELT DIMENSIONS	200S 2-PLY	300S 3-PLY PATENT #4,371,580	MINI ROUGH TOP 3-PLY PATENT #4,371,580	ROUGH TOP CHEVRON CONT. CHEVRON 3-PLY PATENT #4,371,580
MASSEY FERGUSON		GREENLAND (RV)		RIVERRE CASSALIS (RC)		DEUTZ-FAHR
834, 838 RB1582						
Front	8	6" x 210"	3 MRT / TITAN LACE		713062101	N/A
Rear	8	6" x 305"	3 MRT / TITAN LACE		713063051	N/A
825	6	6" x 463"	3 PLY CHEVRON		N/A	71206463
835	8	6" x 545.5"	3 PLY CHEVRON		N/A	71206545
MASSEY FERGUSON STARTER FLAPS						
1550 - 1560 - 1565	4	3" x 58.625"	N/A	N/A	71303058	N/A
1440 - 1450 - 1455	4	3" x 43.625"	N/A	N/A	71303043	N/A
NEW HOLLAND/CNH/FORD		NEW HOLLAND/CNH/FORD		NEW HOLLAND/CNH/FORD		
551 (Ford)	5	6" x 450"	70206450	70506450	71306450	N/A
552 (Ford) (GH059800)	6	6" x 466"	70206466	70506466	71306466	N/A
630 - 638 - 634 (86625675)	6	7" x 272.5"	Thicker 3 MRT (.26)		713072725	N/A
TECHNICAL NOTES: Original equipment belts for older 630/634/638 models were a standard MRT construction. New production units (2001) are equipped with a thicker .26 construction. When replacing belts on older units, you may install the newer .26 construction belt either as a set or individually.						
640 - 644 - 648 - 678 (9843314)(86642411)	6	7" x 343"	Thicker 3MRT (.26)		71307343	N/A
650 - 654 (86642412) (86556992)	6	7" x 420.5"	Thicker 3MRT (.30)		71307420	N/A
660 - 664 (86642412) (86556992)	8	7" x 420.5"	Thicker 3MRT (.30)		71307420	N/A
NEW HOLLAND - SLEDGE ROLL BELT CLEANER STRIP						
644-648-654		7" x 45"	N/A	N/A	71307045	N/A
658-664-678-688 (86548820)		7" x 59.8"	N/A	N/A	71307059	N/A
NEW HOLLAND - BELT SCRAPER AND CLEANING STRIP						
640-644-648-678		5" x 45"	N/A	N/A	71305045	N/A
650-654-658 (9848760)		5" x 59.9"	N/A	N/A	71305059	N/A
660-664-678-688 (9848759)						

TECHNICAL NOTES: Cleaner strips increase baler performance by reducing residue buildup on sledge rolls and belts. Check strips regularly and replace when excess wear is noticed.

READY MADE ASSEMBLIES WITH CLIPPER LACE ATTACHED (See optional Titan or Flexco Rivet)

MAKE & MODEL #	# BELTS PER BALER	BELT DIMENSIONS	200S 2-PLY	300S 3-PLY	MINI ROUGH TOP 3-PLY	ROUGH TOP CHEVRON CONT. CHEVRON 3-PLY
NEW IDEA			NEW IDEA			NEW IDEA
483						
(105003) Top	12	11" x 73.25"	7021107325	7051107325	71311073	N/A
(104712) Bottom	4	11" x 103.5"	70211103	70511103	71311103	N/A
484 Earlier						
(104412) Top	30	4.75" x 73.25"	702047573	705047573	71304757	N/A
(104407) Bottom	5	11" x 103.5"	70211103	70511103	70311103	N/A
484 Newer						
(105005) Top	15	11" x 73.25"	7021107325	7051107325	71311073	N/A
(104467) Bottom	5	11" x 103.5"	70211103	70511103	71311103	N/A
485 - 4855						
(105003) Top	20	11" x 73.25"	7021107325	7051107325	71311073	N/A
(104108) Bottom	4	11" x 121"	70211121	70511121	71311121	N/A
456 - 486 - 4865						
(104107) Top	55	4.75" x 73.25"	702047573	705047573	71304757	N/A
(105003) Top	25	11" x 73.25"	7021107325	7051107325	71311073	N/A
(104108) Bottom	5	11" x 121"	70211121	70511121	71311121	N/A
4643 / 6343						
(700700802)	5	4.8" x 364"	N/A	N/A	7130483641	N/A
4644 / 6344						
(700709185)	6	7" x 366"	3 PLY CONTI. CHEVRON/CLIPPER LACE			71207366
OR						
(700713890)		7" x 366"	3 PLY CONTI. CHEVRON/TITAN LACE			712073661
4664						
(700709999)	6	7" x 562.5"	3 PLY CONTI. CHEVRON/CLIPPER LACE			71207562
OR						
(700713617)		7" x 562.5"	3 PLY CONTI. CHEVRON/TITAN LACE			712075621
4665						
(700709999)	8	7" x 562.5"	3 PLY CONTI. CHEVRON/CLIPPER LACE			71207562
OR						
(700713617)		7" x 562.5"	3 PLY CONTI. CHEVRON/TITAN LACE			712075621
6345						
(700716049)	6	7" x 475"	3 PLY CONTI. CHEVRON/TITAN LACE			712074753
OR						
		7" x 475"	3 PLY CONTI. CHEVRON/FLEXCO RIVET			712074752
OR						
		7" x 475"	3 PLY MRT (.26) / TITAN LACE (Late Model)			713074751
6364 (6 Belts) / 6365 (8 Belts)						
(700717717)		7" x 547"	3 PLY CONTI. CHEVRON/TITAN LACE			712075471
OR						
		7" x 547"	3 PLY CONTI. CHEVRON/FLEXCO RIVET			712075472
OR						
		7" x 547"	3 PLY MRT (.26) / TITAN LACE (Late Model)			713075471

READY MADE ASSEMBLIES WITH CLIPPER LACE ATTACHED

MAKE & MODEL #	# BELTS PER BALER	BELT DIMENSIONS	200S 2-PLY	300S 3-PLY	MINI ROUGH TOP 3-PLY	ROUGH TOP CHEVRON CONT. CHEVRON 3-PLY	
VERMEER		VERMEER			VERMEER		
403F-403G							
	6	4" x 358"	70204358	70504358	71304358	N/A	
		9" x 358"	70209358	70509358	71309358	N/A	
503I							
	4	6" x 428"	N/A	70506428	N/A	N/A	
504C							
	8	4" x 388"	70204388	70504388	71304388	N/A	
		9" x 388"	70209388	70509388	71309388	N/A	
Popular Belt Modification: (4) 4" x 388" Inside and (2) 9" x 388" Outside							
504F-G							
	8	4" x 436"	70204436	70504436	71304436	N/A	
		10" x 436"	70210436	70510436	71310436	N/A	
504H							
	8	4" x 436"	N/A	70504436	71304436	N/A	
		9" x 436"	N/A	70509436	71309436	N/A	
504I-504IS-504L/LS							
5400 Rebel 	6	6" x 424"	N/A	70506424	N/A	N/A	
		14" x 424"	N/A	70514424	N/A	N/A	
505I-505L							
5500 Rebel 	8	6" x 424"	N/A	70506424	N/A	N/A	
		14" x 424"	N/A	70514424	N/A	N/A	
554XL 							
	2	6" x 450"	N/A	70506450	N/A	N/A	
	2	14" x 450"	N/A	70514450	N/A	N/A	
555XL 							
	2	6" x 450"	N/A	70506450	N/A	N/A	
	3	14" x 450"	N/A	70514450	N/A	N/A	
604J							
	6	6.5" x 528"	N/A	70506528	N/A	N/A	
604K-604L							
604XL 	2	6.5" x 528"	N/A	70506528	N/A	N/A	
	2	14" x 528"	N/A	70514528	N/A	N/A	
605A							
	9	4" x 400"	70204400	70504400	71304400	N/A	
		10" x 400"	70210400	70510400	71310400	N/A	

READY MADE ASSEMBLIES WITH CLIPPER LACE ATTACHED

MAKE & MODEL #	# BELTS PER BALER	BELT DIMENSIONS	200S 2-PLY	300S 3-PLY	MINI ROUGH TOP 3-PLY	ROUGH TOP CHEVRON CONT. CHEVRON 3-PLY
605B						
	9	4" x 388"	70204388	70504388	71304388	N/A
		10" x 388"	70210388	70510388	71310388	N/A
Popular Belt Modification to the 605A, B, C, D, and E Balers: (5) 4" Belts Inside and (2) 10" Belts on the Outside. or (4) 10" Belts on the Outside and (1) 4" Belt in the Middle.						
605C						
	9	4" x 440"	70204440	70504440	71304440	N/A
		10" x 440"	70210440	70510440	71310440	N/A
605D						
	9	4" x 450"	70204450	70504450	71304450	N/A
		10" x 450"	70210450	70510450	71310450	N/A
605E-Original						
	5	4" x 457"	70204457	70504457	71304457	N/A
	2	10" x 457"	70210457	70510457	71310457	N/A
605E-Modified						
	5	4" x 440"	70204440	70504440	71304440	N/A
	2	10" x 440"	70210440	70510440	71310440	N/A
605F-G						
	6	4" x 512"	70204512	70504512	71304512	N/A
	2	10" x 512"	70210512	70510512	71310512	N/A
Inside Conversion	(3)	9" x 512"	70209512	70509512	71309512	N/A
Popular Belt Modification: (3) 9" x 512" Inside and (2) 10" x 512" Outside						
605H						
	6	4" x 512"	N/A	70504512	71304512	N/A
	2	9" x 512"	N/A	70509512	71309512	N/A
Inside Conversion	(3)	9" x 512"	N/A	70509512	71309512	N/A
Popular Belt Modification: (5) 9" x 512" Belts Inside and Outside						
605J						
	8	6.5" x 528"	N/A	705065528	N/A	N/A
605J With Traction Roller						
	8	6.5" x 542"	N/A	705065542	N/A	N/A
605K-605L						
605XL 	2	6.5" x 528"	N/A	705065528	N/A	N/A
	3	14" x 528"	N/A	70514528	N/A	N/A
706A						
	11	4" x 493"	70204493	70504493	71304493	N/A
		10" x 493"	70210493	70510493	71310493	N/A
706C						
	12	4" x 541"	70204541	70504541	71304541	N/A
		10" x 541"	70210541	70510541	71310541	N/A

READY MADE ASSEMBLIES WITH CLIPPER LACE ATTACHED

MAKE & MODEL #	# BELTS PER BALER	BELT DIMENSIONS	200S 2-PLY	300S 3-PLY	MINI ROUGH TOP 3-PLY	ROUGH TOP CHEVRON CONT. CHEVRON 3-PLY
VERMEER STARTER FLAPS						
605F, G, H	4	3" x 58.625"	N/A	N/A	71303058	N/A
504F, G, H	4	3" x 43.625"	N/A	N/A	71303043	N/A
403F, G	4	3" x 32.625"	N/A	N/A	71303032	N/A
VICON MCKEE			VICON MCKEE			VICON MCKEE
260						
Upper		7" x 64.5"	70207064	70507675	71307064	N/A
Lower		7" x 104.5"	70207104	705071045	71307104	N/A
560						
Upper	25	11" x 73.25"	7021107325	7051107325	71311073	N/A
Lower	5	11" x 121"	70211121	70511121	71311121	N/A
RP1210, 878						
Upper	45	4.75" x 64.5"	702047564	70504064	713047564	N/A
Newer	30	7" x 64.5"	70207064	70507675	71307064	N/A
Lower	6	7" x 104.5"	70207104	705071045	71307104	N/A
RP1211						
Upper	25	7" x 64.5"	70207064	70507675	71307064	N/A
Lower	5	7" x 96.75"	70207096	70507096	71307096	N/A
RP1510, 1500/1578						
Upper	55	4.75" x 73.25"	702047573	705047573	71304757	N/A
Lower	5	11" x 121"	70211121	70511121	71311121	N/A
RP1511						
Upper	25	11" x 75.75"	70211075	70511075	71311075	N/A
Lower	5	11" x 112"	70211112	70511112	71311112	N/A

TECHNICAL NOTES: For faster bale starts of fixed chamber (soft core) balers, install 3MRT series belts, especially on the bottom and lower tailgate areas. The textured **bottom** assists in pulling hay into the bale chamber while the **lower** tailgate belts turn the hay in starting the core.

Prairie Belting list belt assemblies which meet or exceed original requirements. When you find N/A listings, this generally means that belt style or construction does not meet O.E.M. specifications. You will find many baler models where we offer various up-grade from the original belt style.

EXAMPLE 1: Original specification 2-ply
Up-grade options may include 300s / 3 ply or 3MRT / 3 ply.

EXAMPLE 2: Original specification - Clipper Hooks
Up-grade options may include Titan or Flexco Rivet.

READY MADE ASSEMBLIES WITH CLIPPER LACE ATTACHED

MAKE & MODEL#	# BELTS PER BALER	BELT DIMENSIONS		PRICE
BOTTOM BELTS				
VERMEER				
605A-605B	1	60" x 120"	Clipper Lace	717601201
706A	1	72" x 144"	Clipper Lace	71772144
HESSTON				
5600 (728931)	1	60" x 120"	Clipper Lace	717601201
JOHN DEERE				
500 (AE58828)	1	60" x 138"	Clipper Lace	717601381
410 (AE37525)	5	8" x 74"	Endless	71708074
510 (AE37525)	7	8" x 74"	Endless	71708074
GEHL				
**1400-1450 (074725)	1	44.25" x 55.5"	Clipper Lace	71744055
1400 Early Model (066556)	1	44.25" x 69.5"	Clipper Lace	717440691
1500-1500A-1600 (056480)	1	60" x 95"	Clipper Lace	717609501
1850 (074727)	1	60" x 56.5"	Clipper Lace	71760056
FORD				
**551 (GH066548)	1	44.25" x 55.5"	Clipper Lace	71744055
551 Early Model (GH066556)	1	44.25" x 69.5"	Clipper Lace	717440691
552 (GH056580)	1	60" x 95"	Clipper Lace	717609501
IHC (NO V-GUIDE)				
241, 2400 (210480C92)	1	60" x 120"	Clipper Lace	717601211



****After 5 bales, recheck belt tension-tighten belt if necessary.**

****BOTTOM BELTS REQUIRE FULL TENSION AT ALL TIMES**

* A LOOSE BOTTOM BELT WILL TRACK OUT OF THE V-GUIDE AND ROLL OVER.

* ALWAYS CHECK BOTTOM BELT TENSION BEFORE BALING

INSTALL CABLE:

* We have attached a leader wire to the cable for easier installation.

DO NOT JERK on leader wire with pliers, it will come off.

* Simply snip off the leader wire after installed.

* Tuck the cable back into the hooks on end being pulled.

AFTER INSTALLING BELT:

* Take up roller adjustment to recommended tension (Belt must be tight)

* Run the baler momentarily to check for belt tracking.

All Bottom Belts laced with Clipper Hooks including #332 nylon covered cable with attached leader wire for fast & easy installation.

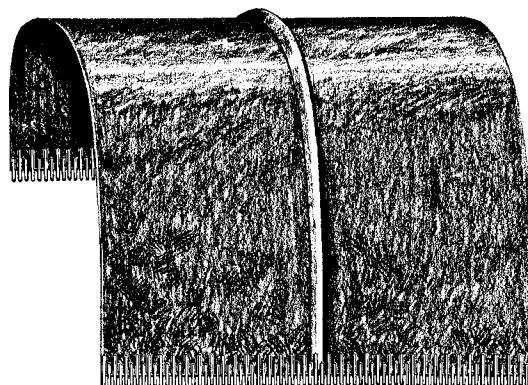

TECHNICAL NOTES: Most problems related to bottom belts are due to lack of tension. This allows the belt to slide out of the V-groove and roll up on its side. When installing a new belt, be sure to re-check belt tension after a few bales.

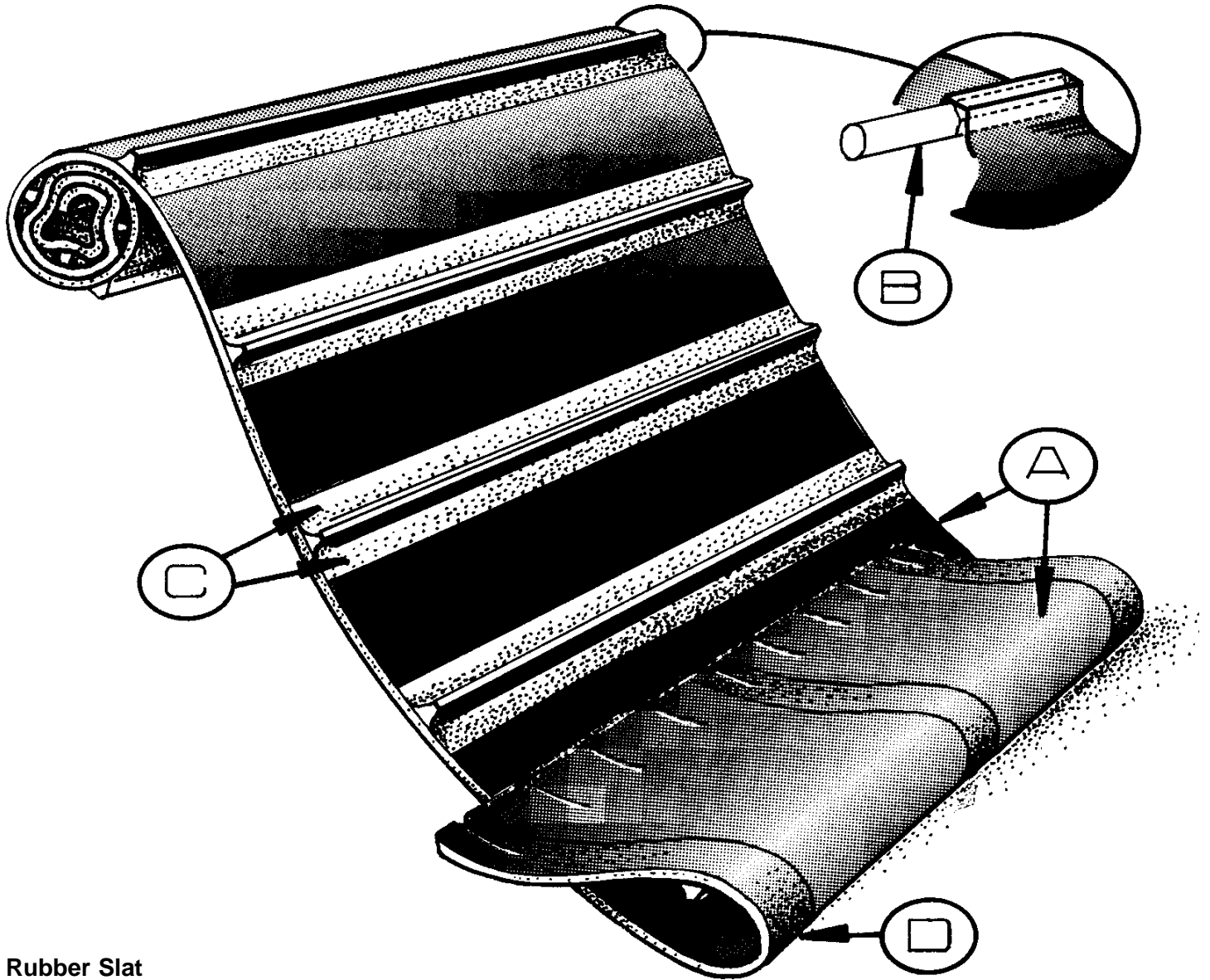

**Rubber Slat
Series**

Prairie Belting's premium replacement belting for pull-type and self-propelled swathers. Prairie Belting incorporates a **rubber cover** on both sides of its canvas which provides added protection against premature wear, abrasion, moisture, sunlight and ozone (see A). Each cleat is vulcanized under heat and pressure to become an integral part of the belt. **Fiberglass reinforcement rods** are standard on Prairie Belting's rubber slat series belting (see B). An extra wide reinforced cleat base with 5/8" square edged cleats provides a stronger bond between the cleat and belt in addition to greater carrying capacity (see C). Rubber slat series swather belting has doubled vulcanized edge reinforcement for added strength and durability. (see D).

ROLL BELTING

BELT SIZE	LENGTH	PART NUMBER
SWATHER BELTING		RUBBER SLAT SERIES
40"	150 Ft.	77440000
40"	300 Ft.	77440000
41"	150 Ft.	77441000
41"	300 Ft.	77441000
41.5"	150 Ft.	77441500
41.5"	300 Ft.	77441500
42"	150 Ft.	77442000
42"	300 Ft.	77442000
42" Recessed Slat	150 Ft.	77442002
42" Recessed Slat	300 Ft.	77442002
44"	150 Ft.	77444000
44"	300 Ft.	77444000
48"	150 Ft.	77448000
48"	300 Ft.	77448000
MacDon Harvest Header Belting		
41.5" With Relieved A-Section Guide	150 Ft.	77441600



Roll belting is priced and sold per foot. When ordering roll belting, order the number of feet as listed in the roll length column. Roll lengths may vary + - 5%. Invoice will reflect actual footage shipped.

Bar & Bolt Fasteners:

Two steel fasteners per set. Bolts, washers and nuts included.

BELT SIZE	BAR SIZE	NUMBER OF HOLES	PART NUMBER
40"	39"	10	6880390
41"	40.5"	8	6880405
41.5"	41"	9	6880410
42"	41.5"	9	6880415
42" (For Recessed Slat)	39"	10	6880390
44"	43.5"	9	6880435

AUTOTRAN					
MODELS/MANUFACTURER #	CUT	SIZE			FOR REFERENCE ONLY
	21' Ext.	41.5"	x	44"	
	21'/25'	41.5"	x	112"	
	21'/25'	41.5"	x	162"	
210-2100	21' R.H.	41.5"	x	264"	
	21' L.H.	41.5"	x	394"	
250-2500	25' R.H.	41.5"	x	313"	
	25' L.H.	41.5"	x	466"	

CASE-IH					
MODELS/MANUFACTURER #	CUT	SIZE			PART #
721	21' L.H.	41.5"	x	128"	67415128
	21' R.H.	41.5"	x	345"	67415345
725	25' L.H.	41.5"	x	229"	67415229
	25' R.H.	41.5"	x	271"	67415271
730	30' L.H.	41.5"	x	271"	67415271
	30' R.H.	41.5"	x	345"	67415345
736	36"	41.5"	x	375"	67415375
742 Duplex	21' L.H. Front	41.5"	x	345"	67415345
	21' R.H. Front	41.5"	x	128"	67415128
	21' L.H. Rear	41.5"	x	193"	67415193
	21' R.H. Rear	41.5"	x	256"	67415256
	21' Center	41.5"	x	122"	67415122
750	25' L.H. Front	41.5"	x	229"	67415229
	25' R.H. Front	41.5"	x	345"	67415345
	25' L.H. Rear	41.5"	x	291"	67415291
	25' R.H. Rear	41.5"	x	256"	67415256
	25' Center	41.5"	x	122"	67415122
	W/Narrow Attach.	41.5"	x	19.5"	67415195
	W/Extension Attach.	41.5"	x	70.5"	67415071
8210 (Up to 1993 Production) (700710161) (700710162)	21' L.H.	42"	x	142" Recessed Slat	674201421
	21' R.H.	42"	x	277" Recessed Slat	674202771
8220 (700710163) (700710162)	25' L.H.	42"	x	238" Recessed Slat	67420238
	25' R.H.	42"	x	277" Recessed Slat	674202771
8230 (700710164) (700710165)	30' L.H.	42"	x	247" Recessed Slat	67420247
	30' R.H.	42"	x	367" Recessed Slat	67420367
8240 (700710965) (700712966)	35' L.H.	42"	x	296" Recessed Slat	674202961
	35' R.H.	42"	x	434" Recessed Slat	674204341

TECHNICAL NOTES: The full slat will not fit on older 8200 series Case-IH P.T. Swathers (pre-1994) due to interference in the draper guide tract flange at the rear of the header. Full slats may be used if this flange is removed. You may also cut off the "D" rings on the underside of the cutter bar that ties down machine during shipment. "D" rings can build up trash and effect draper tracking. In 1993 and newer models, "D" rings were repositioned to eliminate this build-up potential.

CASE (Cont.)			
MODELS/MANUFACTURER #	CUT	SIZE	PART #
1993 production and later			
8210 (700712955) (700712956)	21' L.H. 21' R.H.	42" x 142" Full Slat 42" x 277" Full Slat	67420142 67420277
8220 (700712957) (700712956)	25" L.H. 25' R.H.	42" x 238" Full Slat 42" x 277" Full Slat	674202381 67420277
8230 (700712958) (700712959)	30' L.H. 30' R.H.	42" x 244" Full Slat 42" x 367" Full Slat	67420244 674203670
8240 (700712960) (700712961)	35' L.H. 35' R.H.	42" x 293" Full Slat 42" x 434" Full Slat	67420293 67420434

CCIL			
MODELS/MANUFACTURER #	CUT	SIZE	FOR REFERENCE ONLY
601	12' 15' 18'	41" x 200" 41" x 272" 41" x 338"	
622/626	22' R.H./L.H. 26' R.H./L.H.	41" x 217" 41" x 268"	
660	24' 24' Ext.	41" x 210" 41" x 245.5" 41" x 41.5"	

Cockshutt			
MODELS/MANUFACTURER #	CUT	SIZE	PART #
2/402/E2	12' 15' Ext.	41" x 208" 41" x 275" 41" x 80"	67410208 67410275 67410080
501	(Refer to White 601)		

HESSTON			
MODELS/MANUFACTURER #	Cut	Size	PART #
1200 (Up to 1993 Production) (700710161) (700710162)	21' L.H. 21' R.H.	42" x 142" Recessed 42" x 277" Recessed	674201421 674202771
(700710163) (700710162)	25' L.H. 25' R.H.	42" x 238" Recessed 42" x 277" Recessed	67420238 674202771

HESSTON (Cont.)				
MODELS/MANUFACTURER #	CUT	SIZE		PART #
(700710164)	30' L.H.	42"	x 247" Recessed	67420247
(700710165)	30' R.H.	42"	x 367" Recessed	67420367
(700710965)	35' L.H.	42"	x 296" Recessed	674202961
(700710966)	35' R.H.	42"	x 434" Recessed	674204341
<p>The full slat will not fit on older 1200 Series Hesston P.T. Swathers (pre-1994) due to interference in the draper guide tract flange at the rear of the header. Full slats may be used if this flange is removed. You may also cut off the "D" rings on the underside of the cutter bar that ties down machine during shipment. "D" rings can build up trash and effect draper tracking. In 1993 and newer models, "D" rings were repositioned to eliminate this build-up potential.</p>				
(1993 Production and Later)				
1200				
(700712955)	21' L.H.	42"	x 142" Full Slat	67420142
(700712956)	21' R.H.	42"	x 277" Full Slat	67420277
(700712957)	25' L.H.	42"	x 238" Full Slat	674202381
(700712956)	25' R.H.	42"	x 277" Full Slat	67420277
(700712958)	30' L.H.	42"	x 247" Full Slat	674202470
(700712959)	30' R.H.	42"	x 367" Full Slat	674203670
(700712960)	35' L.H.	42"	x 296" Full Slat	67420296
(700712961)	35' R.H.	42"	x 434" Full Slat	67420434
8050 (Shiftable draper header)				
(700717288)	21'	42"	x	
(700718306)	25'	42"	x	
(700717287)	30"	42"	x	

INTERNATIONAL HARVESTER				
MODELS/MANUFACTURER #	CUT	SIZE		PART #
200				
(597-112-R92)	12'	41.5"	x 193"	67415193
(597-113-R92)	16'	41.5"	x 291"	67415291
1964 & Later				
(597-115-R91)	Cross Conv.	41.5"	x 256"	67415256
(597-116-R91)	Ext.	41.5"	x 39.25"	67415039
(597-114-R91)	Rear Delivery	41.5"	x 128"	67415128
75				
(825-977-C91)	Ext.	41.5"	x 78"	67415078
(826-053-C91)	18' L.H.	41.5"	x 96"	67415096
(826-054-C91)	18' R.H.	41.5"	x 242"	67415242
(825-803-C91)	21' L.H.	41.5"	x 138"	67415138
(825-801-C91)	21' R.H.	41.5"	x 271"	67415271
	15' End Del.			
(823-098-C91)	25' L.H.	41.5"	x 162"	67415162
(825-802-C91)	25' R.H.	41.5"	x 345"	67415345
	18' End Del.			

JOHN DEERE			
MODELS/MANUFACTURER #	CUT	SIZE	FOR REFERENCE ONLY
190	Platform	42" x 78"	
	Platform	42" x 248"	
	Double Swath	42" x 266"	
	D.S. Ext.	42" x 70"	
	D.S. Ext.	42" x 112"	
290	Platform	42" x 143"	
	Platform	42" x 247" Recessed	
580	Ext.	41.5" x 82"	
	18' L.H.	41.5" x 96"	
	18' R.H.	41.5" x 242"	
	21' L.H.	41.5" x 138"	
	21' R.H.	41.5" x 271"	
	25' L.H.	41.5" x 162"	
	25' R.H.	41.5" x 345"	
	30' L.H. 30' R.H.	41.5" x 271" 41.5" x 345"	
590	21' L.H. 21' R.H.	41.5" x 128" 41.5" x 271"	
	25' L.H. 25' R.H.	41.5" x 229" 41.5" x 271"	
	30' L.H. 30' R.H.	41.5" x 271" 41.5" x 345"	
	36' L.H./R.H.	41.5" x 375"	

Massey Ferguson			
MODELS/MANUFACTURER #	CUT	SIZE	PART #
30	12'	41" x 210"	67410210
	15'	41" x 294"	67410294
	16'	41" x 306"	67410306
35	Ext.	41.5" x 82"	67415082
	15'	41.5" x 271"	67415271
	18' L.H. 18' R.H.	41.5" x 96" 41.5" x 242"	67415096 67415242
	21' L.H. 21' R.H.	41.5" x 138" 41.5" x 271"	67415138 67415271
	25' L.H. 15' End Del.	41.5" x 162"	67415162
	25' R.H. 18' End Del.	41.5" x 345"	67415345

MASSEY FERGUSON (Cont.)			
MODELS/MANUFACTURER #	CUT	SIZE	PART #
613, 625 Duplex	30' L.H.	41.5" x 271"	67415271
	30' R.H.	41.5" x 345"	67415345
	36'	41.5" x 375"	67415375
	42' L.H. Front	41.5" x 128"	67415128
	42' R.H. Front	41.5" x 271"	67415271
	42' L.H. Rear	41.5" x 193"	67415193
	42' R.H. Rear	41.5" x 256"	67415256
	50' L.H. Front	41.5" x 229"	67415229
	50' R.H. Front	41.5" x 271"	67415271
	50' L.H. Rear	41.5" x 291"	67415291
	50' R.H. Rear	41.5" x 256"	67415256
	50' Center	41.5" x 122"	67415122

MASSEY HARRIS			
MODELS/MANUFACTURER #	CUT	SIZE	FOR REFERENCE ONLY
4	10'	42" x 191"	
	12'	42" x 217"	
	16'	42" x 304"	
8	12'	41.38" x 236"	
28	16'	41" x 308"	

M&M			
MODELS/MANUFACTURER #	CUT	SIZE	FOR REFERENCE ONLY
M144/M168	12'	41" x 202"	
	14'	41" x 250"	

NEW HOLLAND			
MODELS/MANUFACTURER #	CUT	SIZE	PART #
109	Ext.	41.5" x 82"	67415082
	18' L.H.	41.5" x 96"	67415096
	18' R.H.	41.5" x 242"	67415242
	21' L.H.	41.5" x 138"	67415138
	21' R.H.	41.5" x 271"	67415271
	15' End	41.5" x 271"	67415271
	25' L.H.	41.5" x 162"	67415162
	25' R.H.	41.5" x 345"	67415345
		18' End	41.5" x 345"

OLIVER			
MODELS/MANUFACTURER #	CUT	SIZE	PART #
501	18'	41.5" x 345"	67415345

OWATONNA			
MODELS/MANUFACTURER #	CUT	SIZE	FOR REFERENCE ONLY
245	Ext.	41.88" x 94"	
	18' Short	41.88" x 78.88"	
	18' & 21.5' L.H.	41.88" x 249.63"	
	21.5' Short	41.88" x 162.88"	

RENN			
MODELS/MANUFACTURER #	CUT	SIZE	PART #
1000	Ext.	41.5" x 82"	67415082
	18' L.H.	41.5" x 96"	67415096
	18' R.H.	41.5" x 242"	67415242
	21' L.H.	41.5" x 138"	67415138
	21' R.H.	41.5" x 271"	67415271
	15' End Del.	41.5" x 271"	67415271
	25' L.H.	41.5" x 162"	67415162
	25' R.H., 18'	41.5" x 345"	67415345
	18' End Del.	41.5" x 345"	67415345

VERSATILE			
MODELS/MANUFACTURER #	CUT	SIZE	FOR REFERENCE ONLY
M10	12' End Del.	42" x 203"	
	15' End Del.	42" x 273"	
	18' End Del.	42" x 347"	
	18' C. Del. L.H.	42" x 124"	
	18' C. Del. R.H.	42" x 213"	
	20' C. Del. L.H.	42" x 152"	
	20' C. Del. R.H.	42" x 240"	
	24' L.H./R.H.	42" x 240"	

WESTWARD			
MODELS/MANUFACTURER #	CUT	SIZE	PART #
3000	21' L.H.	41.5" x 128"	67415128
	21' R.H.	41.5" x 271"	67415271
	25' L.H.	41.5" x 225"	67415225
	25' R.H.	41.5" x 271"	67415271
	30' L.H.	41.5" x 271"	67415271
	30' R.H.	41.5" x 345"	67415345
	36'	41.5" x 375"	67415375
3000 Duplex	42' L.H. Front	41.5" x 128"	67415128
	42' R.H. Front	41.5" x 271"	67415271
	42' L.H. Rear	41.5" x 193"	67415193
	42' R.H. Rear	41.5" x 256"	67415256
	50' L.H. Front	41.5" x 225"	67415225
	50' R.H. Front	41.5" x 271"	67415271
	50' L.H. Rear	41.5" x 291"	67415291
	50' R.H. Rear	41.5" x 256"	67415256
	50' Center	41.5" x 122"	67415122
	42'/50' Long	41.5" x 104.5"	67415104
42'/50' Short	41.5" x 70.5"	67415071	

WHITE			
MODELS/MANUFACTURER #	CUT	SIZE	PART #
601 (Cockshutt 501)	Ext.	41.5" x 82"	67415082
	12' End Del.	41.5" x 206"	67415206
	18' L.H.	41.5" x 96"	67415096
	18' R.H.	41.5" x 242"	67415242
	21' L.H.	41.5" x 138"	67415138
	21' R.H.	41.5" x 271"	67415271
	15' End Del.	41.5" x 271"	67415271
	25' L.H.	41.5" x 162"	67415162
	25' R.H.	41.5" x 345"	67415345
	18' End Del.	41.5" x 345"	67415345

Prairie Belting, Inc. Self-Propelled Swather Belting

New lower prices on pre-made assemblies. Premium rubber slat series swather belts with reinforced rods.

CASE			
MODELS/MANUFACTURER #	CUT	SIZE	PART #
CASE 820, 840, 850, 950, 955, 1140 IHC 201, 210, 230			
597-125-R95	10'	40" x 87"	67400087
597-126-R95	12'	40" x 115"	67400115
597-128-R95	14'	40" x 134"	67400134
597-129-R95	16'	40" x 152"	67400152
	20'	40" x 205"	67400205
#855			
	10'	48" x 87"	67480087
	12'	48" x 108"	67480108
	14'	48" x 128"	67480128
	16'	48" x 150"	67480150
	18'	48" x 174"	67480174
	20'	48" x 198"	67480198
CASE-IH			
MODELS/MANUFACTURER #	CUT	SIZE	PART #
#163			
613-583-R92	10'	41.5" x 90"	67415090
613-584-R92	12'	41.5" x 115"	67415115
613-585-R92	14'	41.5" x 138"	67415138
613-586-R92	16'	41.5" x 162"	67415162
#165-201			
892-320-C91 / (831-352-C91)	10'	41.5" x 82"	67415082
597-122-R95 / (831-353-C91)	12'	41.5" x 104"	67415104
597-124-R95	14'	41.5" x 128"	67415128
597-119-R96	16'	41.5" x 152"	674151521
#175-210			
597-121-R94	10.5'	41.5" x 82"	67415082
597-123-R95	13.5'	41.5" x 115"	67415115
597-119-R96	16.5'	41.5" x 152"	674151521
597-120-R96	19.5'	41.5" x 188"	67415188
#230			
829-320-C91	10.5'	41.5" x 82"	67415082
597-122-R95	12.5'	41.5" x 104"	67415104
597-124-R95	14.5'	41.5" x 128"	67415128
597-119-R96	16.5'	41.5" x 152"	674151521
597-120-R96	19.5'	41.5" x 188"	67415188
#4000-5000			
829-320-C91 (831-352-C91)	10.5' 12.5' L.H.	41.5" x 82"	67415082
597-124-R95 (831-354-C91)	12.5' R.H. 16.5' L.H.	41.5" x 128"	67415128
597-122-R95 / (831-353-C91)	14.5' L.H.	41.5" x 104"	67415104
597-119-R96 (831-355-C91)	14.5' R.H. 19.5' L.H.	41.5" x 152"	674151521
829-322-C91	19.5' R.H.	41.5" x 229"	67415229
829-321-C91 / (831-356-C91)	16.5' R.H.	41.5" x 188"	67415188

Prairie Belting, Inc. Self-Propelled Swather Belting

New lower prices on pre-made assemblies. Premium rubber slat series swather belts with reinforced rods.

CASE-IH (Cont.)			
MODELS/MANUFACTURER #	CUT	SIZE	PART #
830-061-C91	24.5' R.H.	41.5" x 278"	67415278
(831-359-C91)	24.5' L.H.	41.5" x 206"	67415206
#4000 After 1978			
597-122-R95	12.5'	41.5" x 104"	67415104
597-124-R95	14.5'	41.5" x 128"	67415128
597-119-R96	16.5'	41.5" x 152"	674151521
597-120-R96	19.5'	41.5" x 188"	67415188
832-190-C91	24.5'	41.5" x 242"	67415242
SELF CLEANING PLATFORM			
#175			
597-125-R95	10.5'	40" x 87"	67400087
597-127-R94	13.5'	40" x 115"	67400115
#6000-6500			
1906345C1	21'	41.5" x 188"	67415188
1906346C1	25'	41.5" x 229"	67415229
1906347C1	30'	41.5" x 291"	67415291
1336268C1	36' L.H.	41.5" x 375"	67415375
1336269C1	36' R.H.	41.5" x 311"	67415311
#8820 (Production Models CFH-0050001 to CFH-0050295)			
700710180	21' Both	42" x 207" (R)	67420207
700710181	25' L.H.	42" x 247" (R)	67420247
700710182	25' R.H.	42" x 207" (R)	67420207
700710183	30' L.H.	42" x 302" (R)	674203021
700710184	30' R.H.	42" x 262" (R)	67420262
700712989	Mini	42" x 46" (R)	674200461
#8820 (Production Models CFH-0050296 and Up)			
700712985	21' Both	42" x 207"	674202070
700712986	25' L.H.	42" x 247"	674202470
700712987	25' R.H.	42" x 207"	674202070
700712988	30' L.H.	42" x 303"	67420303
700712989	30' R.H.	42" x 261"	67420261
#8830			
71700160	15'	42" x 135" (R)	674201351
71700087	18'	42" x 166" (R)	674201661
700708481	21'	42" x 207" (R)	67420207
#8840			
700709104		8" x 87"	FOR REFERENCE ONLY
	Laced Belt	44" x 200" (R)	674402009
CCIL			
MODELS/MANUFACTURER #	CUT	SIZE	FOR REFERENCE ONLY
#500-550			
01-3149 (01-1020)	12'	41" x 109"	
01-3159 (01-2760)	15'	41" x 142"	
01-3160 (01-2761)	18'	41" x 178"	
01-11316 (01-18894)	21'	41" x 214"	

(R) = Recessed Slat

Prairie Belting, Inc. Self-Propelled Swather Belting

CCIL (Cont.)			
MODELS/MANUFACTURER #	CUT	SIZE	FOR REFERENCE ONLY
32638	Ext. 26'	41" x 15"	
32933	26'	41" x 267.5"	
#501			
01-3191 (01-3158)	Ext. 30'	41" x 42.5"	
01-3192 (01-2615)	30'	41" x 278"	
#742 (Hydraflex)			
01-35692	Ext. 42'	41" x 47.4"	
01-37563	42'	41" x 427.1"	

CEREAL IMPL.			
MODELS/MANUFACTURER #	CUT	SIZE	PART #
#722			
45910	13' Deck	41" x 327"	67410327
45909	11' Deck	41" x 278"	67410278
45908	9' Deck	41" x 230"	67410230
45907	7' Deck	41" x 182"	67410182
45906	6.5' Deck	41" x 167"	67410167
45912	2' Ext.	41" x 48"	67410048
45913	Insert	41" x 12"	67410012

COCKSHUTT			
MODELS/MANUFACTURER #	CUT	SIZE	PART #
#423			
XAD 1291	10'	44" x 88"	67440088
XAD 1292	12'	44" x 115"	67440115
XAD 1293	14'	44" x 133"	67440133
XAD 1294	16'	44" x 157"	67440157
#502, 503, 504			
895322L	10'	48" x 87"	67480087
895323L	12'	48" x 108"	67480108
895324L	14'	48" x 129"	67480129
895768L	16'	48" x 150"	67480150
895247L	18'	48" x 174"	67480174
895248L	20'	48" x 198"	67480198

FORD			
MODELS/MANUFACTURER #	CUT	SIZE	PART #
	12'	48" x 108"	67480108
	14'	48" x 129"	67480129
	16'	48" x 150"	67480150
	18'	48" x 174"	67480174
	20'	48" x 198"	67480198

HESSTON			
MODELS/MANUFACTURER #	CUT	SIZE	PART #
All Hesston Models Thru 1974			
028449	10'	44" x 88"	67440088
028456	12'	44" x 115"	67440115

Prairie Belting, Inc. Self-Propelled Swather Belting

HESSTON (Cont.)			
MODELS/MANUFACTURER #	CUT	SIZE	PART #
028464	14'	44" x 133"	67440133
028472	16'	44" x 157"	67440157
028652	18'	44" x 336"	67440336
728105 (Grain/Shift Plat.)	18'	44" x 192" (R)	674401921
828038	18'	44" x 200" (R)	67440200
420, 520			
728383	10'	44" x 75"	67440075
028456	12' R.H.	44" x 115"	67440115
728360	12' L.H.	44" x 91"	67440091
028464	14' R.H.	44" x 133"	67440133
728378	14' L.H.	44" x 115"	67440115
028472	16' R.H.	44" x 157"	67440157
728394	16' L.H.	44" x 139"	67440139
728410	20' R.H.	44" x 205"	67440205
728402	20' L.H.	44" x 189"	67440189
6400, 6450, 6455, 6555, 6655			
828277 (1700152)	12'	42" x 100" (R)	674201001
828285 (1700160)	15'	42" x 135" (R)	674201351
828293 (1700087)	18'	42" x 166" (R)	674201661
828301 (1700103)	21'	42" x 207" (R)	67420207
8100 (Up to 1993 Production)			
700708471 / 700710180	21'	42" x 201" (R)	67420201
700710182 / 700712987	25' R.H.	42" x 207" (R)	67420207
700710181 / 700712986	25' L.H.	42" x 247" (R)	67420247
700706857 / 700710184	30' R.H.	42" x 262" (R)	67420262
700706951 / 700710183	30' L.H.	42" x 302" (R)	674203021
700706858 / 700711197	Mini	42" x 41" (R)	67420041
8100 (1993 Production and Up)			
700712985	21'	42" x 200"	67420200
700712987	25' R.H.	42" x 206"	67420206
700712986	25' L.H.	42" x 246"	67420246
700712989	30' R.H.	42" x 261"	67420261
700712988	30' L.H.	42" x 303"	67420303
700712990	Mini	42" x 40"	67420040
8200			
1700160	15'	42" x 135" (R)	674201351
1700087	18'	42" x 166" (R)	674201661
1700103	21'	42" x 201" (R)	67420201
Double Windrower Attachments			
728105/828343		44" x 192" (R)	674401921
828038/700709104		44" x 200" (R)	67440200
JOHN DEERE			
MODELS/MANUFACTURER #	CUT	SIZE	FOR REFERENCE ONLY
#200, 200A			
AH11237H	10'	42" x 82"	
AH14820H	12'	42" x 107"	
AP26590H	14'	42" x 131"	

(R) = Recessed Slat

Prairie Belting, Inc. Self-Propelled Swather Belting

JOHN DEERE (Cont.)				
MODELS/MANUFACTURER #	CUT	SIZE		FOR REFERENCE ONLY
AH1235H	16' R.H.	42"	x 179"	
AP26509H	16' L.H.	42"	x 131"	
#215, 251A, 880-88				
AH18490H	10'	42"	x 86"	
AH18491H	12'	42"	x 110"	
AH18492H	14'	42"	x 134"	
AH18493H	16'	42"	x 158"	
#78-780				
AE24257	11'	42"	x 95"	
AE23897	15'	42"	x 138"	
AE23783	18'	42"	x 174"	
AE25457	21'	42"	x 210"	
#800-830 (Twin Swath)				
AH18491H	12'	42"	x 110"	
AE23897	15'	42"	x 138"	
AE23783	18'	42"	x 174"	
AE25457	21'	42"	x 210"	
#278, 288 (Shifting Platform)				
AE24846		42"	x 300"	
AE24847		42"	x 47"	
#78, 780, 800, 2250, 2270, 2320, 2420, (1978 and Later)				
AE36767	Ext.	42"	x 16"	
AE36829	12'	42"	x 107"	
AE36830	15'	42"	x 138"	
AE36831	18'	42"	x 174"	
AE36832	21'	42"	x 210"	
AE36834	25'	42"	x 258"	
AE36835	30'	42"	x 310"	
AE33360	36'	42"	x 377"	
#2320 & 2280 (with #130 Platform)				
AE38276	21' TS	42"	x 47"	
AE38140	21' TS	42"	x 186"	
AE36832	21' CD	42"	x 210"	
#2360 (with #160 Platform)				
AW24135	18'	41.5"	x 176"	
AW24062	21'	41.5"	x 184.5"	
AW24063	25'	41.5"	x 229"	
AW24064	30'	41.5"	x 283.5"	
AW24103	Short Deck (Twin Windrowers Only)	41.5"	x 51"	
#215A, 880-118, 800, 830, 2250, 2270 (Narrow Platform)				
AE20966	10'	40"	x 86" (R)	
AE20967	12'	40"	x 110" (R)	
AE20968	14'	40"	x 134" (R)	
AE20969	16'	40"	x 157" (R)	
#78-780				
AE25972	9'	40"	x 73" (R)	
AE23714	11'	40"	x 97" (R)	

(R) = Recessed Slat

Prairie Belting, Inc. Self-Propelled Swather Belting

JOHN DEERE (Cont.)				
MODELS/MANUFACTURER #	CUT	SIZE		FOR REFERENCE ONLY
#78-780, 800, 2250, 2270, 2280 (with #130, 135 Platform) (1978 & Later)				
AE37043	Ext.	40"	x 16" (R)	
AE34797	12'	40"	x 108" (R)	
AE32333	15'	40"	x 138" (R)	
#215, 215A (Auger Platform, Rear Delivery)				
AE20993		35"	x 64"	
MASSEY FERGUSON				
MODELS/MANUFACTURER #	CUT	SIZE		PART #
#20				
1507416M91/1508516M91	10'	48"	x 87"	67480087
1507319M91	12'	48"	x 108"	67480108
1507320M91	14'	48"	x 129"	67480129
1507321M91	16'	48"	x 150"	67480150
#34,36,44				
143116M91/470201 M92/2491413M91	10'	41"	x 86"	67410086
143117M91/470202M92/2491414M91	12'	41"	x 104"	67410104
143118M91/47203M92/2491415M91	14'	41"	x 122"	67410122
143119M91/470204M92/2491416M91	16'	41"	x 146"	67410146
144509M91/470205M92/2491417M91	18'	41"	x 170"	67410170
#220				
	13' Deck	41"	x 327"	67410327
	11' Deck	41"	x 278"	67410278
	9' Deck	41"	x 230"	67410230
	7' Deck	41"	x 182"	67410182
	2' Extension	41"	x 48"	67410048
#655,775,785 Center Delivery				
1043861 M92/1052763M91	12'	41.5"	x 104"	67415104
1043862M92/1052764M91	15'	41.5"	x 140"	67415140
1043863M92/1052765M91	18'	41.5"	x 176"	67415176
1043766M1/1052766M91	21'	41.5"	x 212"	67415212
#855 Center Delivery				
1052756M91/1043703M91	12'	41.5"	x 82"	67415082
1052764M91/1043862M92	15'	41.5"	x 140"	67415140
1052765M91/1043863M92	18'	41.5"	x 176"	67415176
#855 Double Swath				
1056806M91	21' to 30' Ctr. Ext.	41.5"	x 51"	67415051
1057752M91	21'	41.5"	x 188"	67415188
1056807M91	25'	41.5"	x 229"	67415229
1057919M91	30'	41.5"	x 284"	67415284
1069543M91	36' Ext.	41.5"	x 15"	67415015
1069542M91	36' Ext.	41.5"	x 46"	67415046
1069541M91	36'	41.5"	x 311"	67415311
1069540M91	36'	41.5"	x 375"	67415375

(R) = Recessed Slat

Prairie Belting, Inc. Self-Propelled Swather Belting

New lower prices on pre-made assemblies. Premium rubber slat series swather belts with reinforced rods.

MINNEAPOLIS MOLINE			
MODELS/MANUFACTURER #	CUT	SIZE	PART #
#100			
322L	10'	48" x 87"	67480087
323L	12'	48" x 108"	67480108
324L	14'	48" x 129"	67480129
768L	16'	48" x 150"	67480150
247L	18'	48" x 174"	67480174
248L	20'	48" x 198"	67480198
NEW HOLLAND			
MODELS/MANUFACTURER #	CUT	SIZE	FOR REFERENCE ONLY
#900-901			
602853-602840	10'	40" x 85"	
602854-602841	12'	40" x 110"	
602855-602842	14'	40" x 133"	
602856-602843	16'	40" x 157"	
#903, 1100, 1112			
137958-143135	12'	40" x 102"	
137959-143136	14'	40" x 126"	
143114-143137	16'	40" x 150"	
#905			
67487-136070	10'	40" x 78"	
67488-136071	12'	40" x 110"	
67489-136072	14'	40" x 133"	
67490-136073	16'	40" x 157"	
#1090			
275405	12'	41.5" x 104"	
275406	15'	41.5" x 140"	
275407	18'	41.5" x 176"	
275408	21'	41.5" x 212"	
(Double Swath)			
K22685-2	25' DS	41.5" x 51"	
K22686-2	25'	41.5" x 229"	
#1100, 1116, 1495 (Optional Draper Header)			
771940-771939	Ext.	42" x 41.5"	
695882-695881	15'	42" x 138"	
685930- 685928	18'	42" x 174"	
685931-685929	21'	42" x 190.5"	
OLIVER			
MODELS/MANUFACTURER #	CUT	SIZE	PART #
#85, 502, 503			
895322L	10'	48" x 87"	67480087
895323L	12'	48" x 108"	67480108
895324L	14'	48" x 129"	67480129
895768L	16'	48" x 150"	67480150
895247L	18'	48" x 174"	67480174
895248L	20'	48" x 198"	67480198

Prairie Belting, Inc. Self-Propelled Swather Belting

New lower prices on pre-made assemblies. Premium rubber slat series swather belts with reinforced rods.

OWATONNA			
MODELS/MANUFACTURER #	CUT	SIZE	FOR REFERENCE ONLY
#D, 5, 20, 29, 30, 80 (Through 1960)			
070-13956	8'	44" x 63"	
070-13957	10'	44" x 82"	
070-14652	12'	44" x 100"	
070-14653	14'	44" x 122"	
070-14654	16'	44" x 146"	
#25, 29, 30, 35, 80, 81, 270, 350, 700 (1961 & Later)			
070-14788	8'	44" x 66"	
070-10834	10'	44" x 88"	
070-10835	12'	44" x 112"	
070-10836	14'	44" x 128"	
070-10837	16'	44" x 152"	
070-18012	19'	44" x 189" R	
#260			
070-18667	10.5'	44" x 80"	
070-18668	12.5'	44" x 104"	
070-18669	14.5'	44" x 128"	
070-18670	16.5'	44" x 152"	
070-18671	20.5'	44" x 200"	
#262			
070-18682	12.5'	41.88" x 200"	
#281			
070-18682	12.5'	41.88" x 98"	
070-18680	15.5'	41.88" x 134"	
070-18681	18.5'	41.88" x 170"	
070-18683	21.5'	41.5" x 206"	
RENN			
MODELS/MANUFACTURER #	CUT	SIZE	PART #
#2000			
K-22928	12'	41.5" x 104"	67415104
K-22929	15'	41.5" x 140"	67415140
K-22930	18'	41.5" x 176"	67415176
K-22931	21'	41.5" x 212"	67415212
K-22685-2	25' DS	41.5" x 51"	67415051
K-22686-2	25' DS	41.5" x 229"	67415229
VERSATILE			
MODELS/MANUFACTURER #	CUT	SIZE	FOR REFERENCE ONLY
#103, 330, 400			
0000-1384	10'	42" X 80"	
0000-1385	12'	42" X 102"	
0000-1386	15'	42" X 138"	
0000-1387	18'	42" X 174"	
0000-1960	20'	42" X 198"	

Prairie Belting, Inc. Self-Propelled Swather Belting

New lower prices on pre-made assemblies. Premium rubber slat series swather belts with reinforced rods.

VERSATILE (Cont.)			
MODELS/MANUFACTURER #	CUT	SIZE	FOR REFERENCE ONLY
(Prior to 1976) 0000-1960	20' D	42" x 198"	
(After 1976) 0004-1705			
(0005-3051)	20' D	42" x 186"	
#M1950 (Header for Model #256 Tractor)			
0000-75676	19.5' R.H.	42" x 118"	
0000-75677	19.5' L.H.	42" x 225"	
#M2400 (Header Attachment for Model #150 & #256)			
000-29057	24' R.H. Long	42" x 150"	
000-29033	24' R.H. Short	42" x 28"	
000-29035	24' L.H.	42" x 298"	
#M2800 (Header for Model 150, 256, & 276)			
000-47077			
(000-51033)	28' L.H.	42" x 322"	
000-47078			
(000-51034)	28' R.H.	42" x 222"	
#4400			
0000-1385	12'	42" x 102"	
0000-1386	15'	42" x 138"	
0000-1387	18'	42" x 174"	
0000-1960	20'	42" x 198"	
0000-41705			
(000-53051)	20' D	42" x 186"	
0000-54134	22'	42" x 225"	
000-52911	22' D	42" x 210"	
000-63536	24'	42" x 242"	

WESTWARD			
MODELS/MANUFACTURER #	CUT	SIZE	FOR REFERENCE ONLY
#7000 Center Delivery			
	12'	41.5" x 104"	
	15'	41.5" x 140"	
	18'	41.5" x 176"	
#7000 Double Swath			
	21' Platform	41.5" x 184.5"	
	25' Platform	41.5" x 229"	
	30' Platform	41.5" x 283.5"	
	21', 25', 30'		
	Ctr. Ext.	41.5" x 51"	
	36'	41.5" x 15"	
	36' Ext.	41.5" x 45.75"	
	36' Platform	41.5" x 311"	
	36' Platform	41.5" x 374.5"	

Prairie Belting, Inc. Self-Propelled Swather Belting

New lower prices on pre-made assemblies. Premium rubber slat series swather belts with reinforced rods.

WHITE			
MODELS/MANUFACTURER #	CUT	SIZE	PART #
#6200			
31-7976503	12'	41.5" x 104"	67415104
31-7976513	15'	41.5" x 140"	67415140
31-7976523	18'	41.5" x 176"	67415176
31-7976533	21'	41.5" x 212"	67415212
#6400			
K-22685-2	25 D.S.	41.5" x 51"	67415051
K-22686-2	25 D.S.	41.5" x 229"	67415229

Prairie Belting, Inc. Tube-Veyor Belting Grain/Fertilizer

STYLE:	Continuous Chevron
Plies:	2
Covers:	CC x Bare
Clipper Hooks:	#3 Round HT
	(#3 Stainless for Fertilizer)

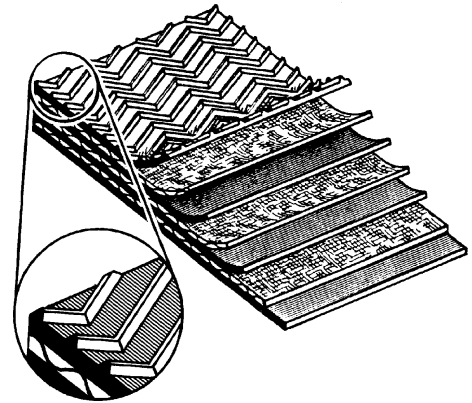

• BATCO • SPEED KING • CONVEY-ALL •

WIDTH	LENGTH	CONT. CHEVRON
12	100FT	71212000
12	200FT	71212000
13	100FT	71213001
13	200FT	71213001
18	100FT	71218000
18	200FT	71218000
20	100FT	71218020
20	200FT	71218020
24	100FT	71218024
24	200FT	71218024

High performance 2-ply polyester carcass with an aggressive durable, and flexible rubber continuous chevron cover. (Replaces lightweight hard plastic "PVC" crescent top).

Available in 100ft or 200ft rolls

Roll Belting is priced and sold by the foot. When ordering, order the number of feet as listed in the length column.

Prairie Belting, Inc. Combine Harvest Header Belts

MAKE/MANUFACTURER #	CUT	SIZE	FOR REFERENCE ONLY
HONEY BEE			
994			
(68710)	30', 36', 39', 42'	42" x 104"	
(67790)	30', 36', 39', 42'	42" x 150"	
(69061)	25'	42" x 198"	
(68005)	30', 36', 39', 42'	42" x 221"	
(64261)	25'	42" x 236"	
(70998)	30', 36', 39', 42'	42" x 248"	
(62939)	30', 36', 39', 42'	42" x 251"	
(67804)	30', 36', 39', 42'	42" x 256"	
(70669)	30', 36', 39', 42'	42" x 274"	
(70996)	30', 36', 39', 42'	42" x 323"	
(70997)	30', 36', 39', 42'	42" x 351"	
(70363)	30', 36', 39', 42'	42" x 374"	
(67810)	30', 36', 39', 42'	42" x 400"	
(71303)	30', 36', 39', 42'	42" x 472"	
(71000)	30', 36', 39', 42'	42" x 517"	

MAKE/MANUFACTURER #	CUT	SIZE	FOR REFERENCE ONLY
CASE IH			
1042			
1052			

MAKE/MANUFACTURER #	CUT	SIZE	FOR REFERENCE ONLY
MACDON -Pull Type			
3000			
(32867)	21' I.H.	41.1" x 126.5" Recessed Slat	
(33797)	21' R.H.	41.5" x 268" Recessed Slat	
(33797)	30' L.H.	41.4" x 268" Recessed Slat	
(37124)	30' R.H.	41.4" x 348" Recessed Slat	
(23923)	25' L.H.	42" x 221" Recessed Slat	
(32919)	25' R.H.	42" x 266" Recessed Slat	
(32919)	30' L.H.	42" x 266" Recessed Slat	
(32920)	30' L.H.	42" x 341" Recessed Slat	

MAKE/MANUFACTURER #	CUT	DELIVERY	SIZE
MACDON 960 (1992-1994)			
(43183)	21' L.H.	Double	41.5" x 174" - V-Guided
(43184)	21' R.H.	Double	41.5" x 222" - V-Guided
(43183)	21' L.H./R.H.	Triple	41.5" x 174" - V-Guided
(43184)	25' L.H.	Double	41.5" x 222" - V-Guided
(43185)	25' R.H.	Double	41.5" x 269" - V-Guided
(43184)	25' L.H./R.H.	Triple	41.5" x 222" - V-Guided
(43186)	30' L.H.	Double	41.5" x 282" - V-Guided
(43187)	30' R.H.	Double	41.5" x 329" - V-Guided
(43186)	30' L.H./R.H.	Triple	41.5" x 282" - V-Guided
(43188)	36' L.H.	Double	41.5" x 354" - V-Guided
(43189)	36' R.H.	Double	41.5" x 402" - V-Guided

Prairie Belting, Inc. Combine Harvest Header Belts

MAKE/MANUFACTURER #	CUT	SIZE	SIZE
MACDON 960 (1995-2000)			
(49515)	21' L.H.	Double	41.5" x 190" - V-Guided
(49516)	21' R.H.	Double	41.5" x 238" - V-Guided
(49515)	21' L.H./R.H.	Triple	41.5" x 190" - V-Guided
(49516)	25' L.H.	Double	41.5" x 238" - V-Guided
(49517)	25' R.H.	Double	41.5" x 286" - V-Guided
(49516)	25' L.H./R.H.	Triple	41.5" x 238" - V-Guided
(49518)	30' L.H.	Double	41.5" x 298" - V-Guided
(49519)	30' R.H.	Double	41.5" x 345" - V-Guided
(49518)	30' L.H./R.H.	Triple	41.5" x 298" - V-Guided
(49507)	36' L.H.	Double	41.5" x 370" - V-Guided
(49521)	36' R.H.	Double	41.5" x 417" - V-Guided
(43182)	Mini	Triple	41.5" x 46" - V-Guided
(43201)	Mini	Triple	41.5" x 49" - V-Guided
MAKE/MANUFACTURER #	CUT	SIZE	SIZE
MACDON 962			
(100265)	30' L.H.	Double	41.5" x 298" - V-Guided
(100266)	30' R.H.	Double	41.5" x 345" - V-Guided
(102267)	36' L.H.	Double	41.5" x 370" - V-Guided
(102268)	36' R.H.	Double	41.5" x 417" - V-Guided
MAKE/MANUFACTURER #	CUT	SIZE	SIZE
MACDON 972			
(100436)	15'	Double	41.5" x 110" - V-Guided
(100427)	18'	Double	41.5" x 146" - V-Guided
(100275)	21'	Double	41.5" x 201" - V-Guided
(100438)	25'	Double	41.5" x 249" - V-Guided
(101912)	30'	Double	41.5" x 309" - V-Guided
(103684)	30'	Double	41.5" x 290" - V-Guided
(101913)	36' L.H.	Double	41.5" x 357" - V-Guided
(101914)	36' R.H.	Double	41.5" x 405" - V-Guided

See bulk rolls of 41.5" V-Guided Swather Belting page 22.

STYLE:	150 Series
Plies:	2
Covers:	1/32 Texture x 1/32 Texture
Overall Gauge:	3/16"
Min. Pulley Dia.:	2"
Clipper Hooks:	#2 or #3

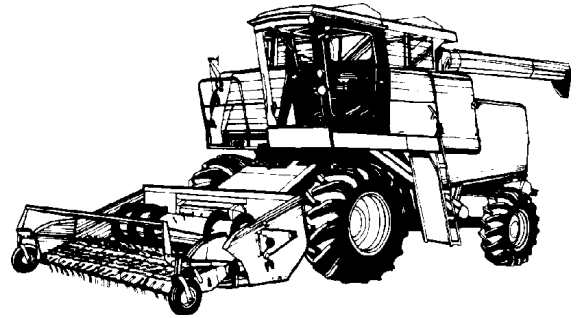

MAKE & MODEL #	DESCRIPTION	DIMENSIONS		PART #	
ALLIS CHALMERS/GLEANER					
A2 / E3 / F	Belt Laced W/Holes Punched	44.25"	x	56.5"	71544056
	Belt Laced W/Teeth (95)	44.25"	x	56.5"	715440560
G / K / L / M	Belt Laced W/Holes Punched	23"	x	79"	71523079
	Belt Laced W/Teeth (60)	23"	x	79"	715230790
CASE #1060-960 F22394/F79158	Belt Laced W/Holes Punched	23.75"	x	57"	71523057
	Belt Laced W/Teeth (49)	23.75"	x	57"	715230570
CASE IH #403/503/1015 37409881	Belt Laced W/Holes Punched	21.75"	x	60.125"	71521060
	Belt Laced W/Teeth (51)	21.75"	x	60.125"	715210600
#2015 374099A1 374197A1	Belt Laced W/Holes Punched	18.75"	x	56.25"	71518057
	Belt Laced W/Teeth (42)	18.75"	x	56.25"	715180570
#715/815/915	Belt Laced W/Holes Punched	35.75"	x	56.75"	71535056
	Belt Laced W/Teeth (44)	35.75"	x	56.75"	715350560
#810/820/914 185527C93	Belt Laced W/Holes Punched	21.75"	x	56.75"	71521056
	Belt Laced W/Teeth (56)	21.75"	x	56.75"	715210560
JOHN DEERE #60/80 AH-62101	Belt Laced W/Holes Punched	20"	x	51"	71520051
	Belt Laced W/Teeth (36)	20"	x	51"	715200510
#66/88 2 Roller AH-64826	Belt Laced W/Holes Punched	22"	x	51"	71522051
	Belt Laced W/Teeth (42)	22"	x	51"	715220510
#110/132/212/214 AH-92200 3 Roller AH-93943 AH-75603	Belt Laced W/Holes Punched	22"	x	65.75"	71522065
	Belt Laced W/Teeth (56)	22"	x	65.75"	715220650
MASSEY FERGUSON #67 1057100M1	Belt Laced W/Holes Punched	22"	x	65.75"	71522065
	Belt Laced W/Teeth (56)	22"	x	65.75"	715220650

Combine Pickup Belt Order With Teeth Are Shipped Without Teeth Attached To The Belt.

STYLE:	Diamond Top
Plies:	2
Covers:	Diamond Top x 1/32
Overall Gauge:	9/32"
Min. Pulley Dia.:	3"
Clipper Hooks:	#4.5

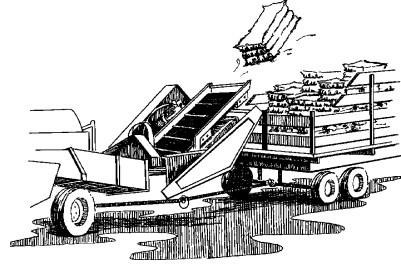

MAKE & MODEL	DESCRIPTION	DIMENSIONS	PART #
ALLIS CHALMERS #301/44	Bale Thrower	11.5" x 50.5"	7137115505
FORD	Bale Thrower	12" x 52.25"	7137120525
HESSTON	Bale Thrower	12" x 64.5"	7137120645
CASE SBX530 (9601394)	Bale Thrower	12" x 72"	713712073
NEW HOLLAND (629278)	Bale Thrower	12" x 81"	7137120812
NEW HOLLAND 72 (9601394)	Bale Thrower	12" x 72"	713712073
MASSEY FERGUSON #583820M91	Bale Thrower	12" x 64.5"	7137120645

Bulk Bale Thrower Belting

SIZE	DESCRIPTION	ROLL LENGTH	PART #
12"	Diamond Top Cover	150 Ft.	7470212

Feeder Wagon Belts

STYLE:	Diamond Top
Plies:	2
Covers:	Diamond Top x Bare
Overall Gauge:	5/16"
Min. Pulley Dia.:	3"
Clipper Hooks:	#4.5

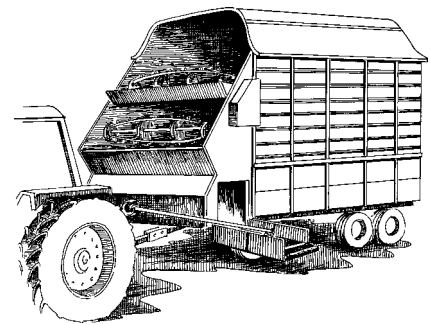

MAKE & MODEL	DESCRIPTION	DIMENSIONS	PART #
GEHL			
B11039A	Apron	19.5" x 175.75"	713819175
B11039D	Apron	19.5" x 173.5"	713819173
B11200	Apron Ext.	19.5" x 88"	713819088
B11281	Dutchman	19.5" x 3"	71381903
INTERNATIONAL			
447-409-R12	Apron	20" x 155"	713820155
477-771-R11	Apron Ext.	20" x 20"	713820020
461-612-R11	Apron Ext.	20" x 85"	713820085
458-181-R11	Apron	20" x 182"	713820182
GROVE			
F3-20-6	Apron	20" x 196.5"	713820196
F3-40-8	Apron Ext.	20" x 72"	713820072

STYLE:	Cleated	Diamond Top
Plies:	2	2
Covers:	Cleated x 1/32	Diamond Top x Bare
Overall Gauge:	9/32"	9/32"
Min. Pulley Dia.:	3"	3"
Flexco Lace:	#125	#125
1" Cleats On 18" Centers		

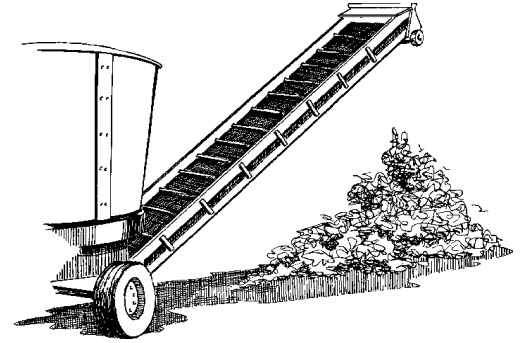

MAKE & MODEL	DESCRIPTION	DIMENSIONS	PART #
E-Z			
	Diamond Top	18" x 540"	70718540
	1" Cleats	18" x 540"	707185401
FARMHAND			
F-880A, F880B, F-890B, GX30	Diamond Top	18" x 399"	70718399
	1" Cleats	18" x 399"	707183991
F-900, F900A	Diamond Top	18" x 540"	70718540
	1" Cleats	18" x 540"	707185401
F-900B, XG 50	Diamond Top	18" x 584"	70718584
	1" Cleats	18" x 584"	707185841
XG50 (Bottom)	Diamond Top	20" x 110"	70720110
XG40/F891A	Diamond Top	18" x 495"	70718495
	1" Cleats	18" x 495"	707184951
HAY BUSTER			
H-900,H-1000, C-9, C-10	Diamond Top	16" x 472"	70716472
(Early Models)	1" Cleats	16" x 472"	707164721
H-1000	Diamond Top	18" x 472"	707184720
(Late Models)	1" Cleats	18" x 472"	707184721
H-1100, C-11-C	Diamond Top	18" x 522"	70718522
(Late Models)	1" Cleats	18" x 522"	707185221
H-1100, C-11-C (Bottom)	1" Cleats	30" x 216"	707302161
(Late Models)			
INTERNATIONAL			
725-72758C1	Diamond Top	18" x 399"	70718399
	1" Cleats	18" x 399"	707183991
750-64302C91	Diamond Top	18" x 540"	70718540
	1" Cleats	18" x 540"	707185401
NEW HOLLAND			
396	Diamond Top	18" x 584"	70718584
	1" Cleats	18" x 584"	707185841
395	Diamond Top	18" x 540"	70718540
	1" Cleats	18" x 540"	707185401
390, 391, 393	Diamond Top	18" x 399"	70718399
	1" Cleats	18" x 399"	707183991
OSWALT			
	Diamond Top	18" x 540"	70718540
	1" Cleats	18" x 540"	707185401

NOTE: Generally, tub grinders which have cleated belts installed as original require cleated replacement belts to reduce the hay rolling back to the bottom of the conveyor. The higher the elevation, the increased need for a cleated belt.